

MWR Triple DC-DC Converters

14 TO 50 VOLT INPUT - 35 WATT

FEATURES

- Input voltage range 14 to 50 V
- Transient protection up to 80 V for one second
- Output short circuit protection
- -55°C to +125°C operation
- Magnetic feedback
- Synchronization
- Inhibit function
- Up to 33 W/in³, 85% efficiency
- Undervoltage lockout



MODELS
OUTPUT VOLTAGE (V)
TRIPLE
3.3 V ±12 V
3.3 V ±15 V
5 V ±12 V
5 V ±15 V

DESCRIPTION

The MWR Series™ of high frequency DC-DC converters offers a wide input voltage range of 14 to 50 volts and up to 35 watts of output power. The units are capable of withstanding short term transients up to 80 volts for one second. The package is a hermetically sealed, welded metal case. Flanged and non-flanged models are available.

CONVERTER DESIGN

MWR Series DC-DC converters are switching regulators that use continuous flyback conversion topology with a clock frequency of approximately 300 kHz. MWR Series converters incorporate two internal converters with one converter phase shifted approximately 120° from the other to create a dual phase/phase-shifted operation. Each of the internal converters operates at the clock frequency. This design provides completely independent regulation with no cross regulation effect between the main and auxiliary outputs and no minimum loading required on the main output. The design minimizes input ripple, greatly reduces output ripple and improves efficiency. See "Figure 1: MWR Block Diagram" on page 2.

LOW NOISE, HIGH AUDIO REJECTION

The MWR converters' feed-forward compensation system provides excellent dynamic response and noise rejection. Audio rejection is typically 40 dB.

The MWR Series converters are provided with internal filtering capacitors that help reduce the need for external components in normal operation. Use our FMCE-0528 EMI filter to meet the requirements of MIL-STD-461C CE03 and CS01 and/or MIL-STD-461D, E and F CE102 and CS101 levels of conducted emissions.

INHIBIT FUNCTION

MWR converters provide an inhibit terminal that can be used to disable internal switching, resulting in no output and very low quiescent input current. The converter is inhibited when the inhibit pin is pulled below 0.8 volts. The unit is enabled when the pin, which is internally connected to a pull-up resistor, is left unconnected or is connected to an open-collector gate. The open circuit output voltage associated with the inhibit pin is 8.5 to 12 V. In the inhibit mode, a maximum of 4 mA must be sunk from the inhibit pin.

SYNCHRONIZATION

Synchronizing the converter with the system clock allows the designer to confine switching noise to clock transitions, minimizing interference and reducing the need for filtering. In sync mode, the converter will run at any frequency between 270 kHz and 330 kHz. The sync control operates with a duty cycle between 40% and 60%.

SHORT CIRCUIT PROTECTION

MWR Series converters provide short circuit protection by restricting the output current to approximately 150% of the full load output current. The output current is sensed in the secondary stage to provide highly predictable and accurate current limiting, and to eliminate foldback characteristics. For better protection, the current limit function of the main and the auxiliary sides are linked together. If one output goes to current limit, the other outputs will be turned off at the same time.

UNDERVOLTAGE LOCKOUT

Undervoltage lockout with hysteresis prevents the units from operating below approximately 12 volts input voltage to keep system current levels smooth, especially during initialization or re-start operations.

MWR Triple DC-DC Converters

14 TO 50 VOLT INPUT - 35 WATT

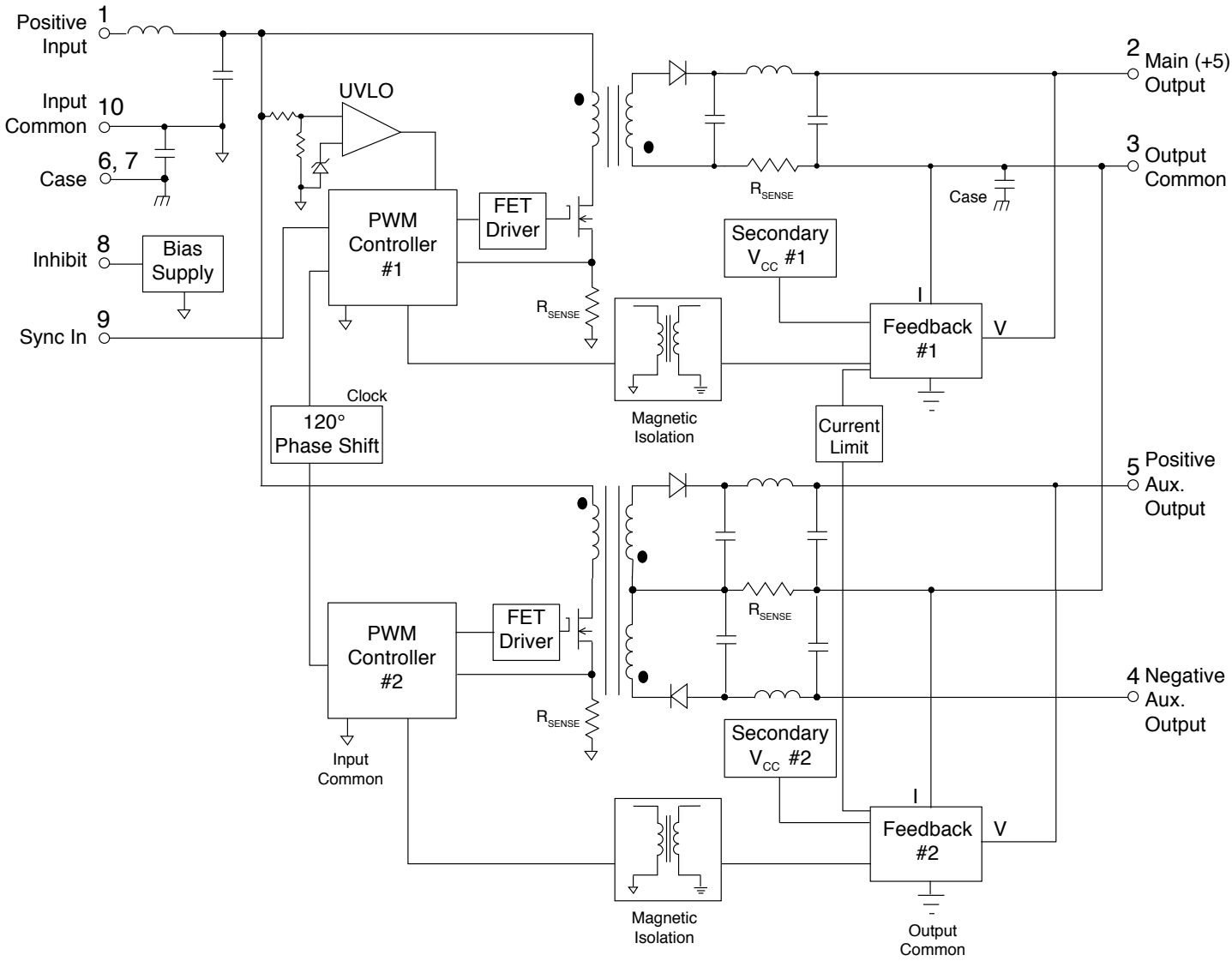

FIGURE 1: MWR BLOCK DIAGRAM

MWR Triple DC-DC Converters

14 TO 50 VOLT INPUT - 35 WATT

PIN OUT	
Pin	Triple Output
1	Positive Input
2	Main Output
3	Output Common
4	Neg. Aux. Output
5	Pos. Aux. Output
6	Case Ground
7	Case Ground
8	Inhibit
9	Sync. In
10	Input Common

TABLE 1: PIN OUT

PINS NOT IN USE	
Inhibit	Leave unconnected
Sync	Leave unconnected or tie to input common

TABLE 2: PINS NOT IN USE

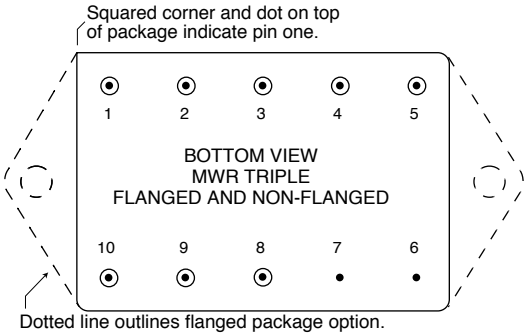

See Figure 15 on page 13 and Figure 16 on page 14 for dimensions.

FIGURE 2: MWR TRIPLE

MWR Triple DC-DC Converters

14 TO 50 VOLT INPUT - 35 WATT

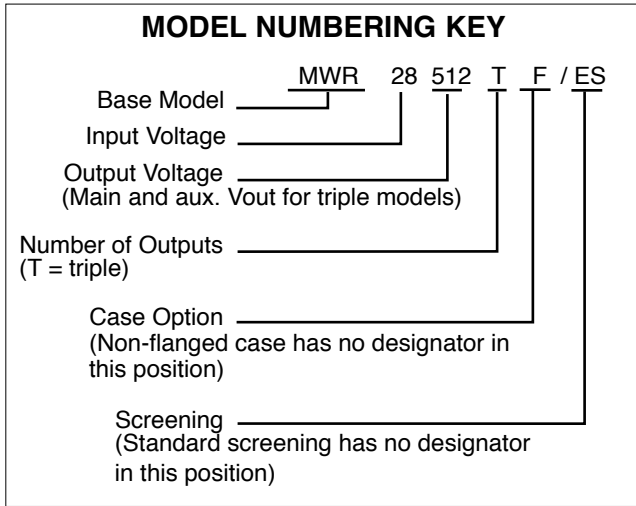

FIGURE 3: MODEL NUMBERING KEY

SMD NUMBERS	
STANDARD MICROCIRCUIT DRAWING (SMD)	MWR SIMILAR PART
5962-XXXXX01HXC IN PROCESS	MWR283R312T/883
5962-XXXXX02HXC IN PROCESS	MWR283R315T/883
5962-XXXXX03HXC IN PROCESS	MWR28512T/883
5962-XXXXX04HXC IN PROCESS	MWR28515T/883
The SMD number shown is for Class H screening, non-flanged. To indicate the flanged case option change the "X" to "Z" in the SMD number. For exact specifications for an SMD product, refer to the SMD drawing. SMDs can be downloaded from: http://www.landandmaritime.dla.mil/programs/smcr	

TABLE 3: SMD CROSS REFERENCE

MODEL NUMBER OPTIONS					
TO DETERMINE THE MODEL NUMBER ENTER ONE OPTION FROM EACH CATEGORY IN THE FORM BELOW.					
CATEGORY	Base Model and Input Voltage	Output Voltage ¹	Number of Outputs ²	Case Options ³	Screening ⁴
OPTIONS	MWR28	3R312, 3R315T, 512T, 515T	T	(non-flanged, leave blank) F (flanged)	(standard, leave blank) ES 883
FILL IN FOR MODEL #	MWR28	_____	_____	_____	/ _____

Notes

1. Output Voltage: An R indicates a decimal point. 3R312T is 3.3 volts main and ±12 volts auxiliaries.
2. Number of Outputs: T is a triple output.
3. Case Options: For the standard case, Figure 15 on page 13, leave the case option blank. For the flanged case option, Figure 16 on page 14, insert the letter F in the Case Option position.
4. Screening: For standard screening leave the screening option blank. For other screening options, insert the desired screening level. For more information see Table 10 on page 15 and Table 11 on page 16.

TABLE 4: MODEL NUMBER OPTIONS

MWR Triple DC-DC Converters

14 TO 50 VOLT INPUT - 35 WATT

TABLE 5: OPERATING CONDITIONS, ALL MODELS, 25°C CASE, 28 VIN, 100% LOAD, UNLESS OTHERWISE SPECIFIED.

MWR SERIES		ALL MODELS			UNITS
PARAMETER	CONDITIONS	MIN	TYP	MAX	
LEAD SOLDERING TEMPERATURE ¹	10 SECONDS MAX.	—	—	300	°C
STORAGE TEMPERATURE ¹		-65	—	+150	°C
CASE OPERATING TEMPERATURE	FULL POWER	-55	—	+125	°C
	ABSOLUTE ¹	-55	—	+135	
DERATING OUTPUT POWER/CURRENT ¹	LINEARLY	From 100% at 125°C to 0% at 135°C			
ESD RATING ¹ MIL-PRF-38534, 3.9.5.8.2	MIL-STD-883, METHOD 3015 CLASS 2	2000 - 3999			V
ISOLATION: INPUT TO OUTPUT OR ANY PIN TO CASE EXCEPT CASE PINS	500 V AT 25°C	100	—	—	Megohms
UNDERVOLTAGE LOCKOUT ¹ -55°C TO +125°C	RISING V _{IN} (TURN ON)	—	12.93	—	V
	FALLING V _{IN} (TURN OFF)	—	11.85	—	
CURRENT LIMIT ² % OF FULL LOAD	MAIN	—	150	—	%
	±AUX. ³	—	130	—	
AUDIO REJECTION ¹		—	40	—	dB
CONVERSION FREQUENCY	FREE RUN -55°C TO +125°C	260	—	340	kHz
SYNCHRONIZATION	INPUT FREQUENCY	270	—	330	kHz
	DUTY CYCLE ¹	40	—	60	%
	ACTIVE LOW	—	—	0.8	V
	ACTIVE HIGH ¹	4.5	—	5.0	
	REFERENCED TO	INPUT COMMON			
IF NOT USED	LEAVE UNCONNECTED				
INHIBIT ACTIVE LOW (OUTPUT DISABLED) Do not apply a voltage to the inhibit pin ⁵	INHIBIT PIN PULLED LOW ⁴	—	—	0.8	V
	INHIBIT PIN SOURCE CURRENT ¹	—	—	4	mA
	REFERENCED TO	INPUT COMMON			
INHIBIT ACTIVE HIGH (OUTPUT ENABLED) Do not apply a voltage to the inhibit pin ⁵	INHIBIT PIN CONDITION	OPEN COLLECTOR OR UNCONNECTED			
	OPEN PIN VOLTAGE ¹	8.5	—	12	V

**For mean time between failures (MTBF) contact Applications Engineering
powerapps@crane-eg.com +1 425-882-3100 option 7**

Notes

- Guaranteed by qualification test and/or analysis. Not an in-line test.
- For better protection, the current limit function of the main and the auxiliary sides are linked together. If one output goes to current limit, the other outputs will be turned off at the same time.
- The over-current limit will trigger when the sum of the auxiliary outputs reach 130% (typical value) of the maximum rated "total" current of both outputs.
- Tested with inhibit pin pulled to ground.
- An external inhibit interface should be used to pull the inhibit low or leave it floating. The inhibit pin can be left unconnected if not used.

MWR Triple DC-DC Converters

14 TO 50 VOLT INPUT - 35 WATT

TABLE 6: ELECTRICAL CHARACTERISTICS -55°C TO +125°C CASE, 28 VIN, 100% LOAD, FREE RUN, UNLESS OTHERWISE SPECIFIED.

TRIPLE OUTPUT MODEL – MWR283R312T		3.3 (MAIN)			±12 (AUXILIARIES)			UNITS
PARAMETER	CONDITIONS	MIN	TYP	MAX	MIN	TYP	MAX	
OUTPUT VOLTAGE	MAIN AND POS. AUX	3.23	3.30	3.37	11.76	12.00	12.24	V
	NEG. AUX.	—	—	—	11.70	12.00	12.30	
OUTPUT CURRENT $V_{IN} = 14$ TO 50 V	MAIN AND EITHER OUTPUT	—	—	3.0	—	±0.833	1.16 ¹	A
	MAX TOTAL AUX	—	—	—	—	—	1.67	
OUTPUT POWER $V_{IN} = 14$ TO 50 V	MAIN AND EITHER OUTPUT	—	—	10	—	±10	14 ¹	W
	MAX TOTAL AUX	—	—	—	—	—	20	
OUTPUT RIPPLE 10 kHz - 20 MHz	$T_C = 25^\circ\text{C}$	—	15	45	—	50	80	mV p-p
	$T_C = -55^\circ\text{C}$ TO $+125^\circ\text{C}$	—	15	60	—	50	120	
LINE REGULATION $V_{IN} = 14$ TO 50 V	MAIN AND POS. AUX	—	5	25	—	5	50	mV
	NEG. AUX.	—	—	—	—	28	120	
LOAD REGULATION BALANCED AUX.	MAIN AND +AUX., NL - FL	—	5	25	—	5	50	mV
	-AUX., NL - FL	—	—	—	—	20	100	
CROSS REGULATION ² $T_C = 25^\circ\text{C}$	EFFECT ON NEGATIVE AUXILIARY	—	—	—	—	250	600	mV
INPUT VOLTAGE	CONTINUOUS	14	28	50	—	—	—	V
	TRANSIENT 1 sec ¹	—	—	80	—	—	—	V
INPUT CURRENT	NO LOAD	—	50	65	—	—	—	mA
	INHIBITED	—	2.5	4	—	—	—	
INPUT RIPPLE CURRENT ³	10 kHz - 20 MHz	—	36	100	—	—	—	mA p-p
EFFICIENCY	$T_C = 25^\circ\text{C}$	78	81	—	—	—	—	%
	$T_C = -55^\circ\text{C}$ TO $+125^\circ\text{C}$	77	—	—	—	—	—	
LOAD FAULT ^{4, 5}	POWER DISSIPATION	—	6	9.5	—	5	9.5	W
	RECOVERY ¹	—	15	20	—	—	20	ms
STEP LOAD RESPONSE ^{5, 6} 50% - 100% - 50%	TRANSIENT	—	±75	±350	—	±150	±600	mV pk
	RECOVERY	—	120	400	—	175	600	μs
STEP LINE RESPONSE ^{1, 5, 7} 14 - 40 - 14 V_{IN}	TRANSIENT	—	±100	±400	—	±200	±400	mV pk
	RECOVERY	—	400	600	—	200	600	μs
START-UP ^{5, 8}	DELAY	—	15	20	—	—	20	ms
	OVERSHOOT ¹	—	5	33	—	5	60	mV pk
CAPACITIVE LOAD ^{1, 9}	25°C	—	—	1000	—	—	500	μF

Notes

- Guaranteed by design and/or analysis. Not an in-line test.
- Effect on negative output when switching loads simultaneously from/to 30%-70% where 100% is the total power of both auxiliaries.
- At loads <20% of full load, higher input ripple current is possible.
- Limit applies to both main and auxiliary outputs, tested separately.
- Recovery and startup times are measured from application of the transient or change in condition to the point at which V_{OUT} is within 1% of final value. $C_L = 0$.
- Step load transition time $10 \mu\text{s} \pm 1 \mu\text{s}$.
- Step line transition time $100 \mu\text{s} \pm 20 \mu\text{s}$.
- Tested on release from inhibit.
- No effect on dc performance. Applies to each auxiliary.

MWR Triple DC-DC Converters

14 TO 50 VOLT INPUT - 35 WATT

TABLE 7: ELECTRICAL CHARACTERISTICS -55°C TO +125°C CASE, 28 VIN, 100% LOAD, FREE RUN, UNLESS OTHERWISE SPECIFIED.

TRIPLE OUTPUT MODEL – MWR283R315T		3.3 (MAIN)			±15 (AUXILIARIES)			UNITS
PARAMETER	CONDITIONS	MIN	TYP	MAX	MIN	TYP	MAX	
OUTPUT VOLTAGE	MAIN AND POS. AUX	3.23	3.30	3.37	14.70	15.00	15.30	V
	NEG. AUX.	—	—	—	14.62	15.00	15.38	
OUTPUT CURRENT $V_{IN} = 14$ TO 50 V	MAIN AND EITHER OUTPUT	—	—	3.0	—	±0.667	0.93 ¹	A
	MAX TOTAL AUX	—	—	—	—	—	1.34	
OUTPUT POWER $V_{IN} = 14$ TO 50 V	MAIN AND EITHER OUTPUT	—	—	10	—	±10	14 ¹	W
	MAX TOTAL AUX	—	—	—	—	—	20	
OUTPUT RIPPLE 10 kHz - 20 MHz	$T_C = 25^\circ\text{C}$	—	15	45	—	35	80	mV p-p
	$T_C = -55^\circ\text{C}$ TO $+125^\circ\text{C}$	—	15	60	—	35	100	
LINE REGULATION $V_{IN} = 14$ TO 50 V	MAIN AND POS. AUX	—	5	25	—	5	50	mV
	NEG. AUX.	—	—	—	—	25	120	
LOAD REGULATION BALANCED AUX.	MAIN AND +AUX., NL - FL	—	5	25	—	5	50	mV
	-AUX., NL - FL	—	—	—	—	28	100	
CROSS REGULATION ² $T_C = 25^\circ\text{C}$	EFFECT ON NEGATIVE AUXILIARY	—	—	—	—	250	600	mV
INPUT VOLTAGE	CONTINUOUS	14	28	50	—	—	—	V
	TRANSIENT 1 sec ¹	—	—	80	—	—	—	V
INPUT CURRENT	NO LOAD	—	50	70	—	—	—	mA
	INHIBITED	—	2.5	4	—	—	—	
INPUT RIPPLE CURRENT ³	10 kHz - 20 MHz	—	36	100	—	—	—	mA p-p
EFFICIENCY	$T_C = 25^\circ\text{C}$	79	82	—	—	—	—	%
	$T_C = -55^\circ\text{C}$ TO $+125^\circ\text{C}$	78	—	—	—	—	—	
LOAD FAULT ^{4, 5}	POWER DISSIPATION	—	6	9.5	—	5	9.5	W
	RECOVERY ¹	—	15	20	—	—	20	ms
STEP LOAD RESPONSE ^{5, 6} 50% - 100% - 50%	TRANSIENT	—	±75	±350	—	±175	±600	mV pk
	RECOVERY	—	120	400	—	145	600	μs
STEP LINE RESPONSE ^{1, 5, 7} 14 - 40 - 14 V_{IN}	TRANSIENT	—	±100	±400	—	±200	±400	mV pk
	RECOVERY	—	400	600	—	200	700	μs
START-UP ^{5, 8}	DELAY	—	15	20	—	—	20	ms
	OVERSHOOT ¹	—	5	33	—	5	70	mV pk
CAPACITIVE LOAD ^{1, 9}	25°C	—	—	1000	—	—	500	μF

Notes

- Guaranteed by design and/or analysis. Not an in-line test.
- Effect on negative output when switching loads simultaneously from/to 30%-70% where 100% is the total power of both auxiliaries.
- At loads <20% of full load, higher input ripple current is possible.
- Limit applies to both main and auxiliary outputs, tested separately.
- Recovery and startup times are measured from application of the transient or change in condition to the point at which V_{OUT} is within 1% of final value. $C_L = 0$.
- Step load transition time $10 \mu\text{s} \pm 1 \mu\text{s}$.
- Step line transition time $100 \mu\text{s} \pm 20 \mu\text{s}$.
- Tested on release from inhibit.
- No effect on dc performance. Applies to each auxiliary.

MWR Triple DC-DC Converters

14 TO 50 VOLT INPUT - 35 WATT

TABLE 8: ELECTRICAL CHARACTERISTICS -55°C TO +125°C CASE, 28 VIN, 100% LOAD, FREE RUN, UNLESS OTHERWISE SPECIFIED.

TRIPLE OUTPUT MODEL – MWR28512T		5 (MAIN)			±12 (AUXILIARIES)			UNITS
PARAMETER	CONDITIONS	MIN	TYP	MAX	MIN	TYP	MAX	
OUTPUT VOLTAGE	MAIN AND POS. AUX	4.90	5.00	5.10	11.76	12.00	12.24	V
	NEG. AUX.	—	—	—	11.70	12.00	12.30	
OUTPUT CURRENT $V_{IN} = 14$ TO 50 V	MAIN AND EITHER OUTPUT	—	—	3.0	—	±0.833	1.16 ¹	A
	MAX TOTAL AUX	—	—	—	—	—	1.67	
OUTPUT POWER $V_{IN} = 14$ TO 50 V	MAIN AND EITHER OUTPUT	—	—	15	—	±10	14 ¹	W
	MAX TOTAL AUX	—	—	—	—	—	20	
OUTPUT RIPPLE 10 kHz - 20 MHz	$T_C = 25^\circ\text{C}$	—	20	45	—	50	80	mV p-p
	$T_C = -55^\circ\text{C}$ TO $+125^\circ\text{C}$	—	20	60	—	50	120	
LINE REGULATION $V_{IN} = 14$ TO 50 V	MAIN AND POS. AUX	—	5	25	—	5	50	mV
	NEG. AUX.	—	—	—	—	28	120	
LOAD REGULATION BALANCED AUX.	MAIN AND +AUX., NL - FL	—	5	25	—	5	50	mV
	-AUX., NL - FL	—	—	—	—	20	100	
CROSS REGULATION ² $T_C = 25^\circ\text{C}$	EFFECT ON NEGATIVE AUXILIARY	—	—	—	—	250	600	mV
INPUT VOLTAGE	CONTINUOUS	14	28	50	—	—	—	V
	TRANSIENT 1 sec ¹	—	—	80	—	—	—	V
INPUT CURRENT	NO LOAD	—	50	70	—	—	—	mA
	INHIBITED	—	2.5	4	—	—	—	
INPUT RIPPLE CURRENT ³	10 kHz - 20 MHz	—	40	100	—	—	—	mA p-p
EFFICIENCY	$T_C = 25^\circ\text{C}$	81	84	—	—	—	—	%
	$T_C = -55^\circ\text{C}$ TO $+125^\circ\text{C}$	80	—	—	—	—	—	
LOAD FAULT ^{4, 5}	POWER DISSIPATION	—	7	9.5	—	5	9.5	W
	RECOVERY ¹	—	15	20	—	—	20	ms
STEP LOAD RESPONSE ^{5, 6} 50% - 100% - 50%	TRANSIENT	—	±75	±350	—	±150	±600	mV pk
	RECOVERY	—	230	400	—	175	600	μs
STEP LINE RESPONSE ^{1, 5, 7} 14 - 40 - 14 V_{IN}	TRANSIENT	—	±100	±400	—	±200	±400	mV pk
	RECOVERY	—	400	900	—	200	600	μs
START-UP ^{5, 8}	DELAY	—	15	20	—	—	20	ms
	OVERSHOOT ¹	—	5	50	—	5	60	mV pk
CAPACITIVE LOAD ^{1, 9}	25°C	—	—	1000	—	—	500	μF

Notes

- Guaranteed by design and/or analysis. Not an in-line test.
- Effect on negative output when switching loads simultaneously from/to 30%-70% where 100% is the total power of both auxiliaries.
- At loads <20% of full load, higher input ripple current is possible.
- Limit applies to both main and auxiliary outputs, tested separately.
- Recovery and startup times are measured from application of the transient or change in condition to the point at which V_{OUT} is within 1% of final value. $C_L = 0$.
- Step load transition time $10 \mu\text{s} \pm 1 \mu\text{s}$.
- Step line transition time $100 \mu\text{s} \pm 20 \mu\text{s}$.
- Tested on release from inhibit.
- No effect on dc performance. Applies to each auxiliary.

MWR Triple DC-DC Converters

14 TO 50 VOLT INPUT - 35 WATT

TABLE 9: ELECTRICAL CHARACTERISTICS -55°C TO +125°C CASE, 28 VIN, 100% LOAD, FREE RUN, UNLESS OTHERWISE SPECIFIED.

TRIPLE OUTPUT MODEL – MWR28515T		5 (MAIN)			±15 (AUXILIARIES)			UNITS
PARAMETER	CONDITIONS	MIN	TYP	MAX	MIN	TYP	MAX	
OUTPUT VOLTAGE	MAIN AND POS. AUX	4.90	5.00	5.10	14.70	15.00	15.30	V
	NEG. AUX.	—	—	—	14.62	15.00	15.38	
OUTPUT CURRENT $V_{IN} = 14$ TO 50 V	MAIN AND EITHER OUTPUT	—	—	3.0	—	±0.667	0.93 ¹	A
	MAX TOTAL AUX	—	—	—	—	—	1.34	
OUTPUT POWER $V_{IN} = 14$ TO 50 V	MAIN AND EITHER OUTPUT	—	—	15	—	±10	14 ¹	W
	MAX TOTAL AUX	—	—	—	—	—	20	
OUTPUT RIPPLE 10 kHz - 20 MHz	$T_C = 25^\circ\text{C}$	—	20	45	—	35	80	mV p-p
	$T_C = -55^\circ\text{C}$ TO $+125^\circ\text{C}$	—	20	60	—	35	100	
LINE REGULATION $V_{IN} = 14$ TO 50 V	MAIN AND POS. AUX	—	5	25	—	5	50	mV
	NEG. AUX.	—	—	—	—	28	120	
LOAD REGULATION BALANCED AUX.	MAIN AND +AUX., NL - FL	—	5	25	—	50	50	mV
	-AUX., NL - FL	—	—	—	—	25	100	
CROSS REGULATION ² $T_C = 25^\circ\text{C}$	EFFECT ON NEGATIVE AUXILIARY	—	—	—	—	250	600	mV
INPUT VOLTAGE	CONTINUOUS	14	28	50	—	—	—	V
	TRANSIENT 1 sec ¹	—	—	80	—	—	—	V
INPUT CURRENT	NO LOAD	—	50	70	—	—	—	mA
	INHIBITED	—	2.5	4	—	—	—	
INPUT RIPPLE CURRENT ³	10 kHz - 20 MHz	—	40	100	—	—	—	mA p-p
EFFICIENCY	$T_C = 25^\circ\text{C}$	82	85	—	—	—	—	%
	$T_C = -55^\circ\text{C}$ TO $+125^\circ\text{C}$	81	—	—	—	—	—	
LOAD FAULT ^{4, 5}	POWER DISSIPATION	—	7	9.5	—	5	9.5	W
	RECOVERY ¹	—	15	20	—	—	20	ms
STEP LOAD RESPONSE ^{5, 6} 50% - 100% - 50%	TRANSIENT	—	±75	±350	—	±175	±600	mV pk
	RECOVERY	—	230	400	—	145	600	μs
STEP LINE RESPONSE ^{1, 5, 7} 14 - 40 - 14 V_{IN}	TRANSIENT	—	±100	±400	—	±200	±400	mV pk
	RECOVERY	—	400	900	—	200	700	μs
START-UP ^{5, 8}	DELAY	—	15	20	—	—	20	ms
	OVERSHOOT ¹	—	5	50	—	5	70	mV pk
CAPACITIVE LOAD ^{1, 9}	25°C	—	—	1000	—	—	500	μF

Notes

- Guaranteed by design and/or analysis. Not an in-line test.
- Effect on negative output when switching loads simultaneously from/to 30%-70% where 100% is the total power of both auxiliaries.
- At loads <20% of full load, higher input ripple current is possible.
- Limit applies to both main and auxiliary outputs, tested separately.
- Recovery and startup times are measured from application of the transient or change in condition to the point at which V_{OUT} is within 1% of final value. $C_L = 0$.
- Step load transition time $10 \mu\text{s} \pm 1 \mu\text{s}$.
- Step line transition time $100 \mu\text{s} \pm 20 \mu\text{s}$.
- Tested on release from inhibit.
- No effect on dc performance. Applies to each auxiliary.

MWR Triple DC-DC Converters

14 TO 50 VOLT INPUT - 35 WATT

TYPICAL PERFORMANCE PLOTS: 25°C CASE, 28 VIN, 100% LOAD, FREE RUN, UNLESS OTHERWISE SPECIFIED.
FOR REFERENCE ONLY, NOT GUARANTEED SPECIFICATIONS.

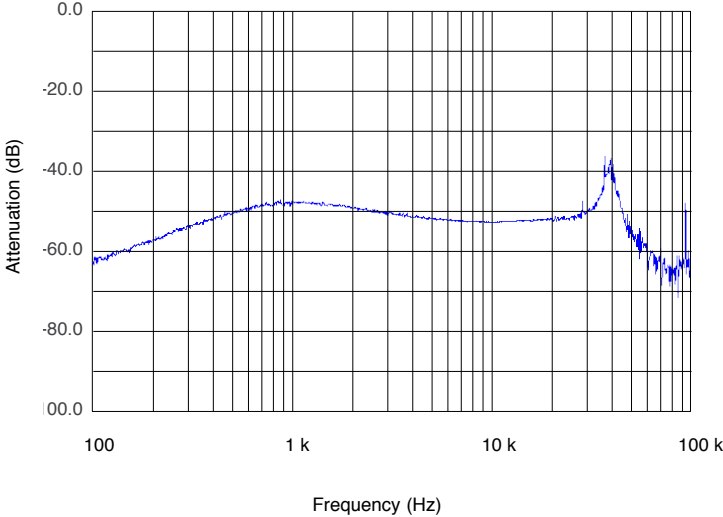

MWR28515T AUDIO REJECTION WITH FMCE-0528
FIGURE 4

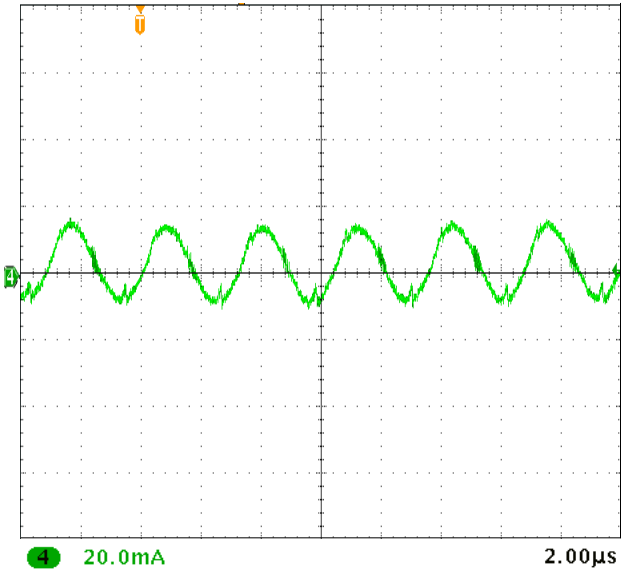

UNITS ARE PER DIVISION
MWR28515T INPUT RIPPLE
FIGURE 5

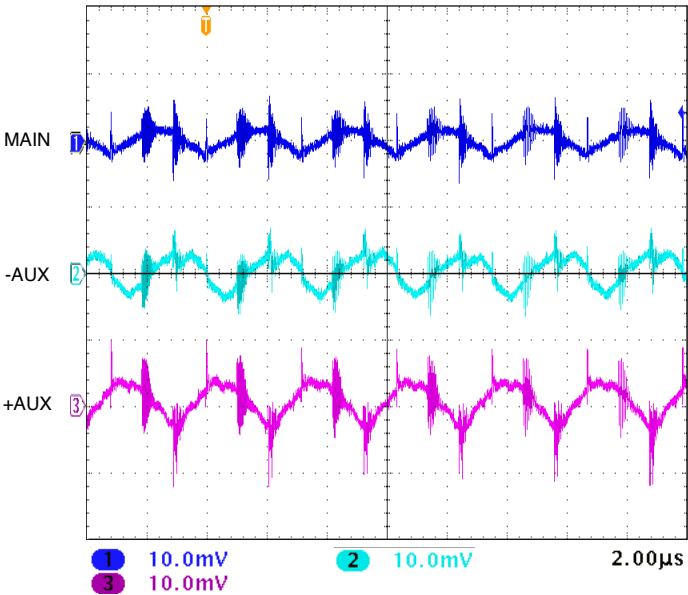

UNITS ARE PER DIVISION
MWR28515T OUTPUT RIPPLE
FIGURE 6

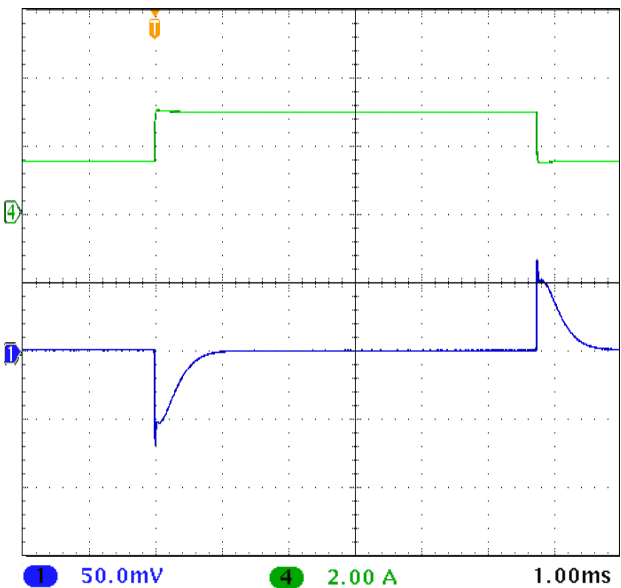

UNITS ARE PER DIVISION, 10 µS SLEW RATE
MWR28515T STEP LOAD MAIN, 50% - 100% - 50%
FIGURE 7

MWR Triple DC-DC Converters

14 TO 50 VOLT INPUT - 35 WATT

TYPICAL PERFORMANCE PLOTS: 25°C CASE, 28 V_{IN}, 100% LOAD, FREE RUN, UNLESS OTHERWISE SPECIFIED.
FOR REFERENCE ONLY, NOT GUARANTEED SPECIFICATIONS.

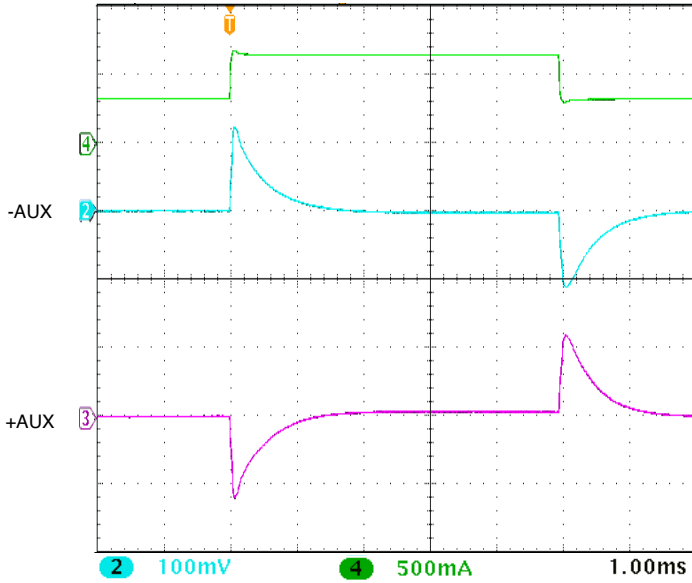

UNITS ARE PER DIVISION, 10 μ S SLEW RATE
MWR28515T STEP LOAD \pm AUX., 50% - 100% - 50%
FIGURE 8

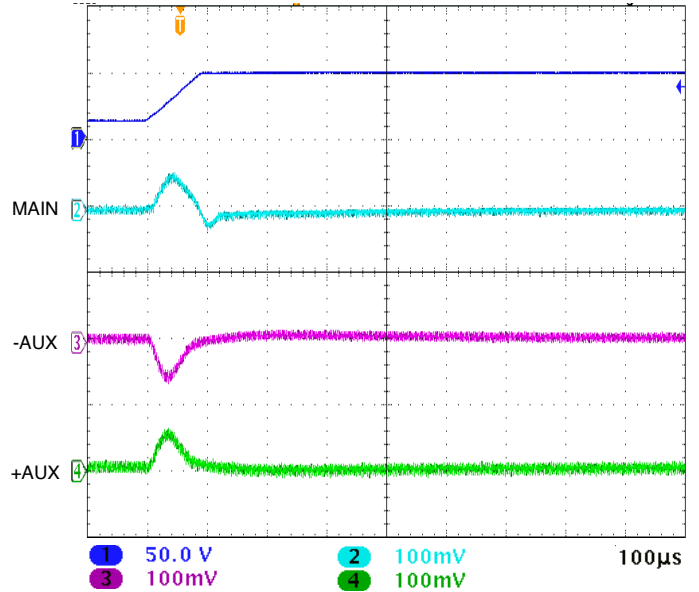

UNITS ARE PER DIVISION
MWR28515T STEP LINE 14 V_{IN} TO 50 V_{IN}
FIGURE 9

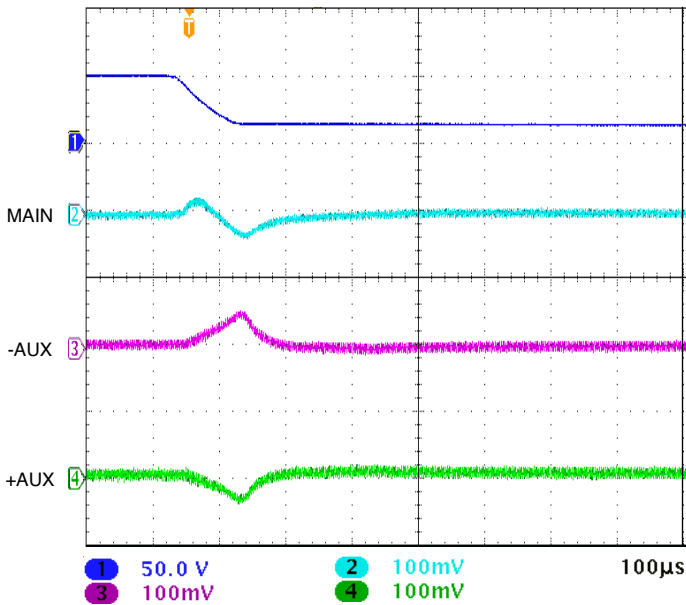

UNITS ARE PER DIVISION
MWR28515T STEP LINE 50 V_{IN} TO 14 V_{IN}
FIGURE 10

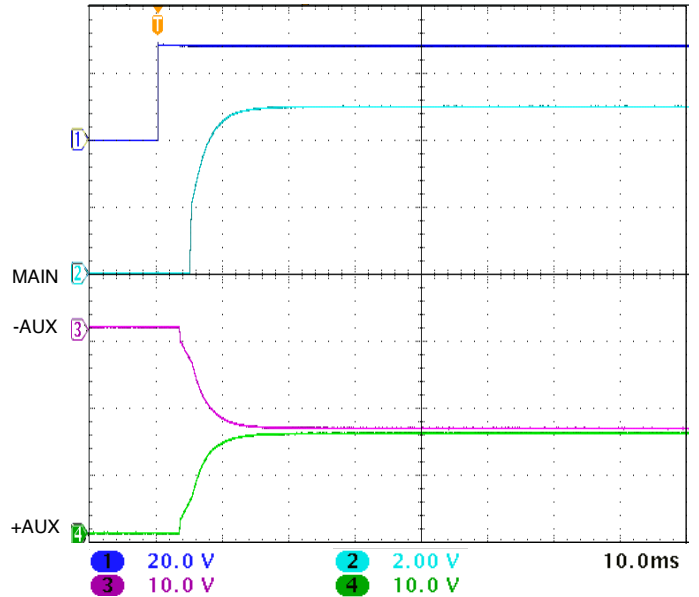

UNITS ARE PER DIVISION
MWR28515T START-UP INTO FULL LOAD
FIGURE 11

MWR Triple DC-DC Converters

14 TO 50 VOLT INPUT - 35 WATT

TYPICAL PERFORMANCE PLOTS: 25°C CASE, 28 VIN, 100% LOAD, FREE RUN, UNLESS OTHERWISE SPECIFIED.
 FOR REFERENCE ONLY, NOT GUARANTEED SPECIFICATIONS.

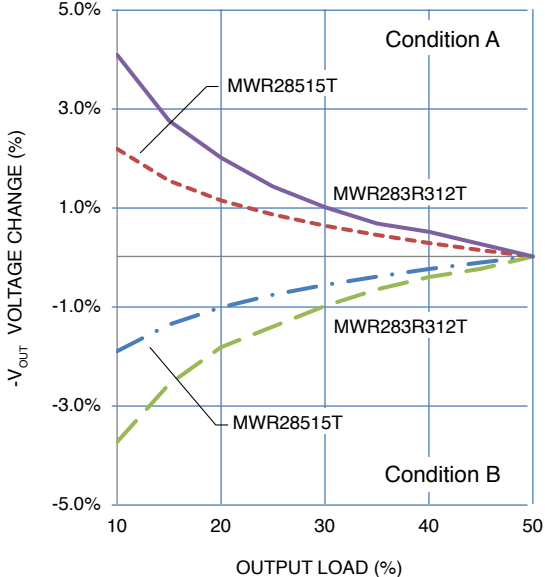

CONDITION A LOAD: -V 50%, +V 50% TO 10%
 CONDITION B LOAD: +V 50%, -V 50% TO 10%
 CROSS REGULATION

FIGURE 12

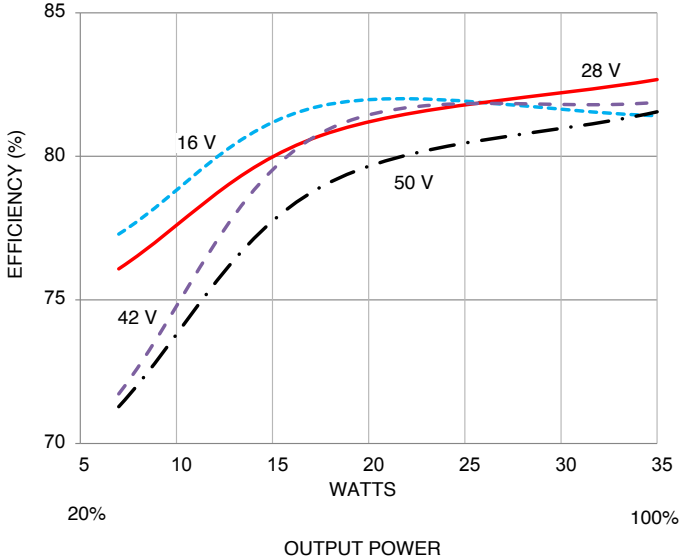

MWR283R312T EFFICIENCY

FIGURE 13

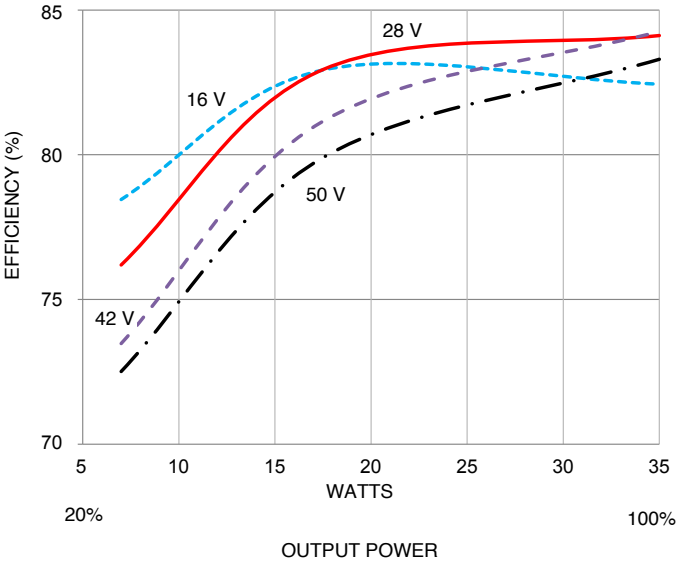

MWR28515T EFFICIENCY

FIGURE 14

MWR Triple DC-DC Converters

14 TO 50 VOLT INPUT - 35 WATT

BOTTOM VIEW MWR

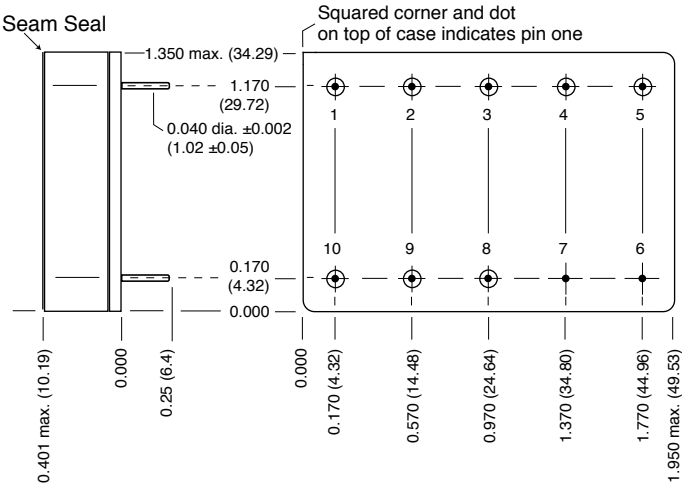

Weight: 58 grams max.

Case dimensions in inches (mm)
Tolerance ±0.005 (0.13) for three decimal places
±0.01 (0.3) for two decimal places
unless otherwise specified

CAUTION
Heat from reflow or wave soldering may damage the device.
Solder pins individually with heat application not exceeding 300°C for 10 seconds per pin.

Materials
Header Cold Rolled Steel/Nickel/Gold
Cover Kovar/Nickel
Pins #52 alloy/Gold ceramic seal
Gold plating of 50 - 150 microinches is included in pin diameter
Seal hole 0.120 ±0.002 (3.05 ± 0.05)

Case F1 MWR, Rev A, 2015.05.29
Please refer to the numerical dimensions for accuracy.

FIGURE 15: MWR

MWR Triple DC-DC Converters

14 TO 50 VOLT INPUT - 35 WATT

BOTTOM VIEW MWR FLANGED

Flanged cases: Designator "F" required in Case Option position of model number.

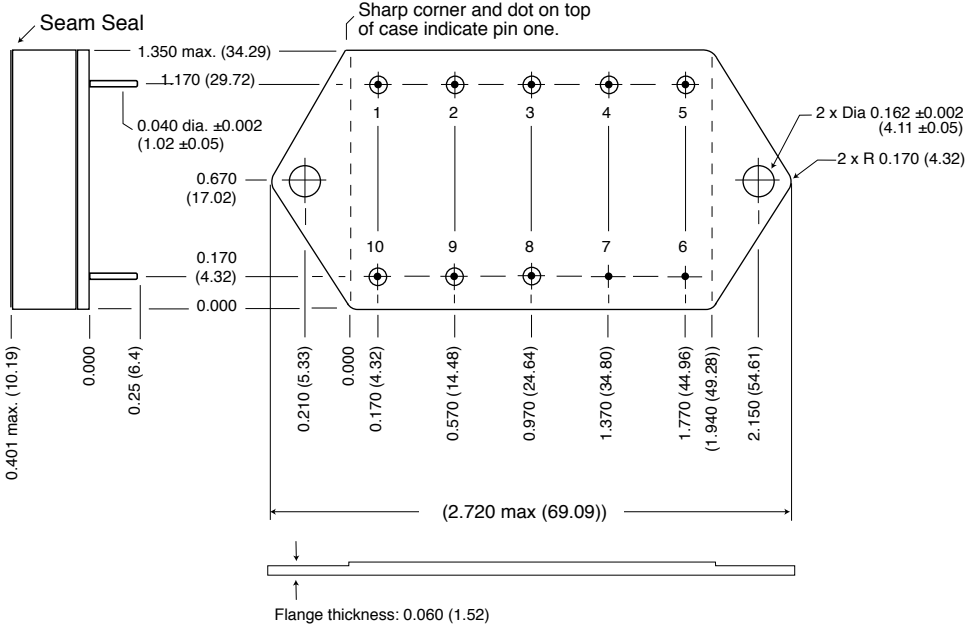

Weight: 60 grams maximum

Case dimensions in inches (mm)
Tolerance ± 0.005 (0.13) for three decimal places
 ± 0.01 (0.3) for two decimal places
unless otherwise specified

CAUTION
Heat from reflow or wave soldering may damage the device. Solder pins individually with heat application not exceeding 300°C for 10 seconds per pin.

Materials
Header Cold Rolled Steel/Nickel/Gold
Cover Kovar/Nickel
Pins #52 alloy/Gold ceramic seal
Gold plating of 50 - 150 microinches included in pin diameter
Seal Hole: 0.120 ± 0.002 (3.04 ± 0.05)

Case J1 MWR, Rev A, 2015.05.29
Please refer to the numerical dimensions for accuracy.

FIGURE 16: MWR FLANGED

MWR Triple DC-DC Converters

14 TO 50 VOLT INPUT - 35 WATT

ELEMENT EVALUATION ¹ HIGH RELIABILITY /883 (CLASS H)

COMPONENT-LEVEL TEST PERFORMED	QML	
	CLASS H /883	
	M/S ²	P ³
Element Electrical	■	■
Visual	■	■
Internal Visual	■	
Final Electrical	■	■
Wire Bond Evaluation	■	■

Notes

1. Element evaluation does not apply to standard and /ES product.
2. M/S = Active components (microcircuit and semiconductor die).
3. P = Passive components, Class H element evaluation. Not applicable to standard and /ES element evaluation.

TABLE 10: ELEMENT EVALUATION

MWR Triple DC-DC Converters

14 TO 50 VOLT INPUT - 35 WATT

ENVIRONMENTAL SCREENING HIGH RELIABILITY STANDARD, /ES AND /883 (CLASS H)

TEST PERFORMED	NON-QML ¹		QML ²
	STANDARD	/ES	CLASS H /883
Pre-cap Inspection, Method 2017, 2032	■	■	■
Temperature Cycle (10 times)			
Method 1010, Cond. C, -65°C to +150°C, ambient			■
Method 1010, Cond. B, -55°C to +125°C, ambient		■	
Constant Acceleration			
Method 2001, 3000 g			■
Method 2001, 500 g		■	
PIND, Test Method 2020, Cond. A			■ ³
Burn-in Method 1015, +125°C case, typical ⁴			
96 hours		■	
160 hours			■
Final Electrical Test, MIL-PRF-38534, Group A,			
Subgroups 1 through 6, -55°C, +25°C, +125°C case			■
Subgroups 1 and 4, +25°C case	■	■	
Hermeticity Test			
Gross Leak, Cond. C ₁ , fluorocarbon		■	■
Fine Leak, Cond. A ₂ , helium		■	■
Gross Leak, Dip	■		
Final visual inspection, Method 2009	■	■	■

Test methods are referenced to MIL-STD-883 as determined by MIL-PRF-38534.

Notes

- Standard and ES are non-QML products and may not meet all of the requirements of MIL-PRF-38534.
- All processes are QML qualified and performed by certified operators.
- Not required by DLA but performed to assure product quality.
- Burn-in temperature designed to bring the case temperature to +125°C minimum.
Burn-in is a powered test.

TABLE 11: ENVIRONMENTAL SCREENING