

MOR Single and Dual DC-DC Converters

28 VOLT INPUT – 120 WATT

FEATURES

- Parallel operation with current share, up to 5 units (540 watts)
- Output flexibility, trim of 60% to 110%
- Operating temperature -55°C to +125°C
- Input voltage 16 to 40 V
- Transient protection 50 V for 120 ms
- Fully isolated, magnetic feedback
- Fixed high frequency switching
- Remote sense on single output models
- Inhibit function
- Sync In and Sync Out
- Indefinite short circuit protection
- High power density with up to 87% efficiency



MODELS	
OUTPUT VOLTAGE (V)	
SINGLE	DUAL
3.3	±3.3
5	±5
6.3	±6.3
9.5	±9.5
12	±12
15	±15

DESCRIPTION

The Interpoint® MOR Series™ of DC-DC converters offers up to 120 watts of power in a low profile package with a 16 to 40 volt input. The MOR converters are manufactured in our fully certified and qualified MIL-PRF-38534 Class H production facility and packaged in hermetically sealed steel cases. They are ideal for use in programs requiring high reliability, small size, and high efficiency. Full operation over the military temperature range, -55°C to +125°C, makes the MOR Series an ideal choice for military, aerospace, space, and other high reliability applications. In compliance with MIL-STD-704D, the converters will withstand transients of up to 50 volts for up to 120 milliseconds. Use Interpoint FMCE-1528 EMI filter to meet the requirements of MIL-STD-461C CE03 and MIL-STD-461D, E and F CE102 levels of conducted emissions.

The converters are offered with standard screening, “ES” screening, or fully compliant to “883” MIL-PRF-38534 Class H screening. Standard microcircuit drawings (SMD) are available.

The MOR Series converters incorporate a single-ended forward topology which uses a constant frequency Pulse Width Modulator (PWM) current mode control design and switches at 550 kHz, nominal.

SPAN VOLTAGE

The dual models can be used as a single output voltage by connecting the load between positive and negative outputs, leaving the common unconnected resulting in double the output voltage. For example, MOR2815D can be used as a 30 volt output. When using a dual to double the output voltage (span voltage) the maximum load capacitance across the span voltage is half that specified for each output.

SHORT CIRCUIT PROTECTION

The converters also provide short circuit protection by restricting the current to 125% of the full load output current, typical.

INHIBIT FUNCTION

All models offer two inhibits, one referenced to input common and one referenced sense return (single output models) or to output common (dual output models). A remote sense function is available on single output models.

TRIM FUNCTION

Using the trim function, the MOR Series can provide any output from 2 to 33 V. For example, trimming the two 15 volt outputs of the 15 dual (MOR2815D) to 14 volts, and then spanning the outputs will provide a 28 volt output.

MOR Single and Dual DC-DC Converters

28 VOLT INPUT – 120 WATT

HOW TO USE THE FUNCTIONS

INPUT VOLTAGE

Steady state voltage range is 16 to 40 V. Transient range is 40 to 50 V for a maximum of 120 msec. All models include a soft-start function to prevent large current draw and minimize overshoot.

EMI INPUT FILTERS

Internal 500 volt capacitors (dielectric working voltage (DWV) 700 volts) are connected between the case and input common and between the case and output common.

Use Interpoint FMCE-1528 EMI filter to meet the requirements of MIL-STD-461C CE03 and CS01 and MIL-STD-461D, E and F CE102 and CS101. When using an external input filter it is important that the case of the filter and the case of the converter be connected through as low an impedance as possible. Direct connection of the baseplates to chassis ground is the best connection. If connected by a single trace, the trace should be as wide as it is long. See Figure 1.

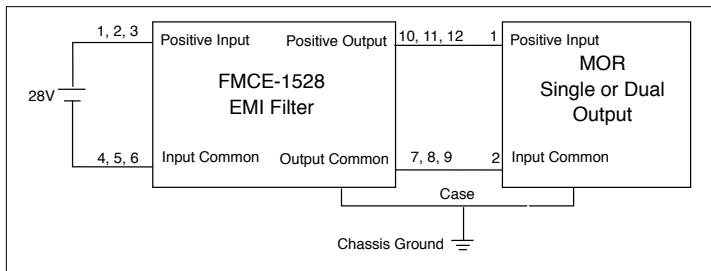

FIGURE 1: EXTERNAL FILTER CONNECTION

TRIM

Both single and dual output models include a trim function. Output voltage can be trimmed from 60% up to 110% of nominal V out . When trimming up, do not exceed the maximum output power. When trimming down, do not exceed the maximum output current. See Figure 2.

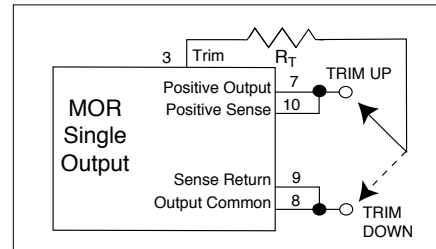

FIGURE 2: TRIM – SINGLE

On dual models the positive output is regulated and the negative output is transformer coupled (cross-regulated) to the positive output. When trimming the duals, both output voltages will be adjusted equally. See Figure 3.

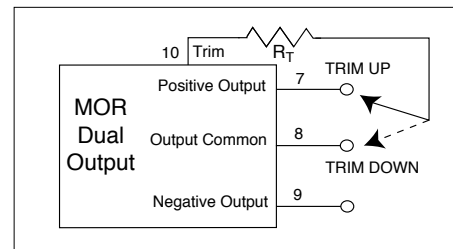

FIGURE 3: TRIM – DUAL

TRIM FORMULAS

Trim Up:

$$a = \frac{V_o}{V_{o \text{ nominal}}}, 1.0 \leq a \leq 1.1$$

$$R_T \text{ (k}\Omega\text{)} = \left(\frac{\left(\frac{V_o}{2.5} - 1 \right) \cdot 20}{(a - 1)} \right) - 50$$

Example: $V_{o \text{ nominal}} = 5.0$, $V_o = 5.25$, $a = 1.05$, $R_T = 390 \text{ k}\Omega$

Trim Down:

$$a = \frac{V_o}{V_{o \text{ nominal}}}, 0.6 \leq a \leq 1.0$$

$$R_T \text{ (k}\Omega\text{)} = \frac{50 \cdot a - 30}{1 - a}$$

Example: $V_{o \text{ nominal}} = 5.0$, $V_o = 4.5$, $a = 0.9$, $R_T = 150 \text{ k}\Omega$

MOR Single and Dual DC-DC Converters

28 VOLT INPUT – 120 WATT

INHIBIT 1 AND 2

Two inhibit terminals disable switching, resulting in no output and very low quiescent input current. The two inhibit pins allow access to an inhibit function on either side of the isolation barrier to help maintain isolation.

An open collector is required for interfacing with both of the inhibit pins. Pulling either inhibit pin low will inhibit the converter. Leaving the pins open will enable the converter. Inhibit 1 is referenced to Input Common. Inhibit 2 is referenced to Sense Return for single output models and to Output Common for dual output models.

The open circuit voltage (unit enabled) for Inhibit 1 is 13 V and for Inhibit 2 it is up to 8 V. Leave the Inhibit pins unconnected if not used. The required active low voltage level is 0.8 V maximum for Inhibit 1 and 0.2 V maximum for Inhibit 2. See Figure 4, Figure 5 and Table 6.

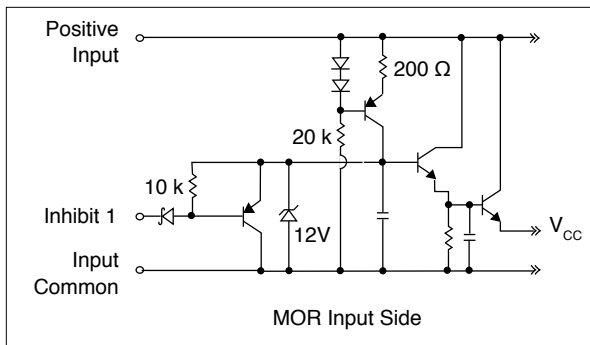

FIGURE 4: INHIBIT 1

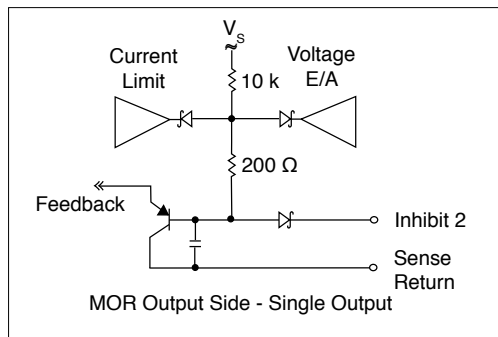

FIGURE 5: INHIBIT 2

UNDERVOLTAGE LOCKOUT

Undervoltage lockout prevents the units from operating below approximately 15.5 V input voltage to keep system current levels smooth, especially during initialization or re-start operations.

SYNC IN AND SYNC OUT

The MOR converters can be synchronized to the system clock by applying an active high sync signal to the Sync In pin. Sync Out can be used to synchronize other components to the MOR converter's switching frequency.

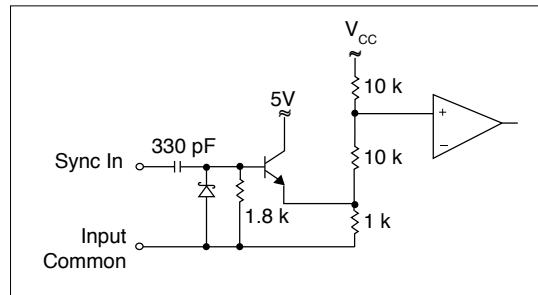

FIGURE 6: SYNC IN

The frequency range for external synchronization is 525 to 625 kHz. The requirements for an external signal are 20% to 50% duty cycle, $0 \leq L \leq 0.8$ V and $4.5 \leq H \leq 9$ V. Both Sync In and Sync Out are referenced to input common. Sync In should be connected to input common if not used. See Figure 6 and Figure 7.

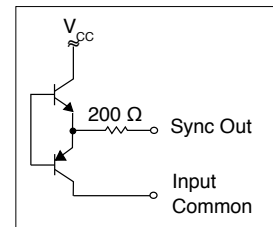

FIGURE 7: SYNC OUT

POSITIVE OUTPUT, NEGATIVE OUTPUT AND OUTPUT COMMON

Output current is typically limited to 125% of maximum specified current under short circuit or load fault conditions.

Single output models operate from no load to full load. Dual output models with balanced loads operate from no load to full load. For dual models with unbalanced loads, at least 10% of the total output power must be drawn from the positive output at all times, however, the negative output does not require a minimum load. See notes 3 and 4, cross regulation, under the Electrical Characteristics Tables.

MOR Single and Dual DC-DC Converters

28 VOLT INPUT – 120 WATT

PARALLELING (SHARE PIN)

By using the Share pin, up to five single or dual converters may be paralleled for a total output power of up to 540 watts, depending on model. To calculate available power, multiply the number of converters (up to five) by their maximum output power. Multiply the result by 90% for total available power. See Figure 8 for the internal circuit. The converters will share within 10% of each other at 25% to 90% rated power. MOR converters feature true n+1 redundancy for reliability in critical applications. See Figure 9 for the proper connections.

All Positive Outputs and Positive Senses should be connected to a common point. All Negative Outputs and Sense Returns should be connected to a common point. The Share pin is referenced to Sense Return. Leave the share pin floating (unconnected) if not used. Also see Figure 9.

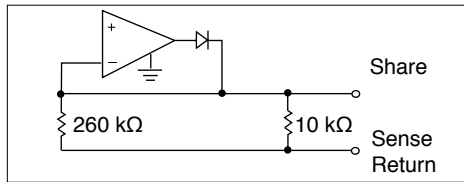

FIGURE 8: SHARE

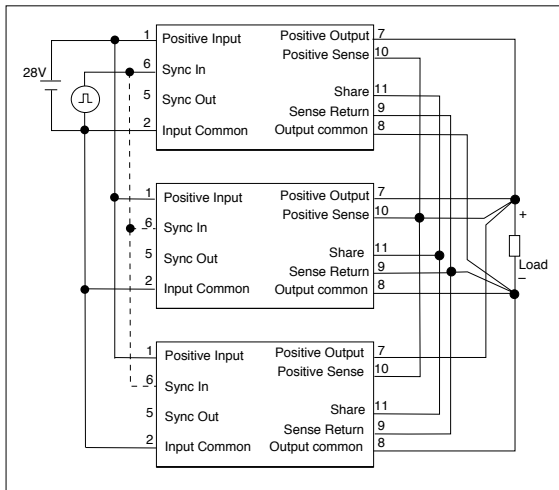

FIGURE 9: PARALLELING

POSITIVE SENSE AND SENSE RETURN

A special remote sensing feature maintains the desired output voltage at the load. See Figure 9. When this feature is not used, connect the sense lines to their respective output terminals. See Figure 10. Remote sensing is available on single output models only. Do not exceed 110% of V_{out} and do not exceed maximum output power.

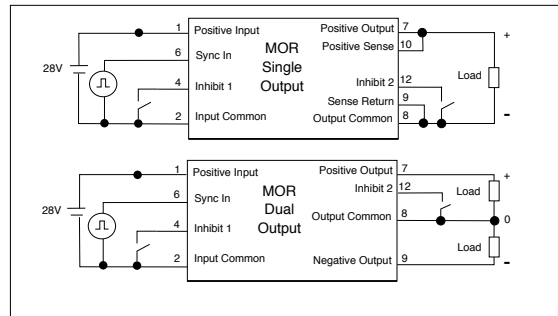

FIGURE 10: TYPICAL CONNECTIONS

INCREASE OUTPUT VOLTAGE BY SPANNING OUTPUTS

Dual outputs may be spanned to increase the output voltage. Our duals can also be configured as a single output where the positive output is used as one rail and the negative output is used as the other rail. As an example the positive and negative 15 volt dual can be configured as a single 30 volt output. This can be used as a positive 30 volt output or a negative 30 volt output. See Figure 11. In all cases Output Common of the converter is not connected.

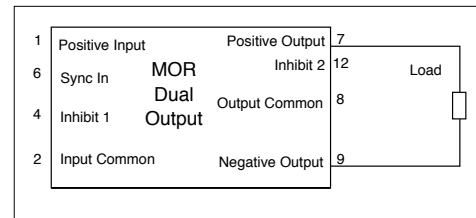

FIGURE 11: SPANNED OUTPUTS – DUAL MODEL

If the dual is configured as a positive 30 volt output the negative output would be used as system ground and the positive output would be used as the positive 30 volt output.

If the dual is configured as a negative 30 volt output the positive output would be used as system ground and the negative output would be used as the negative 30 volt output.

The maximum capacitance when using a span voltage on a dual is half the value specified for each output. Inhibit 2 cannot be referenced to system ground when spanning voltages. Leave Inhibit 2 floating if not in use. If Inhibit 2 is needed, please contact Applications Engineering at 425.882.3100 option 7 or powerapps@craneae.com.

MOR Single and Dual DC-DC Converters

28 VOLT INPUT – 120 WATT

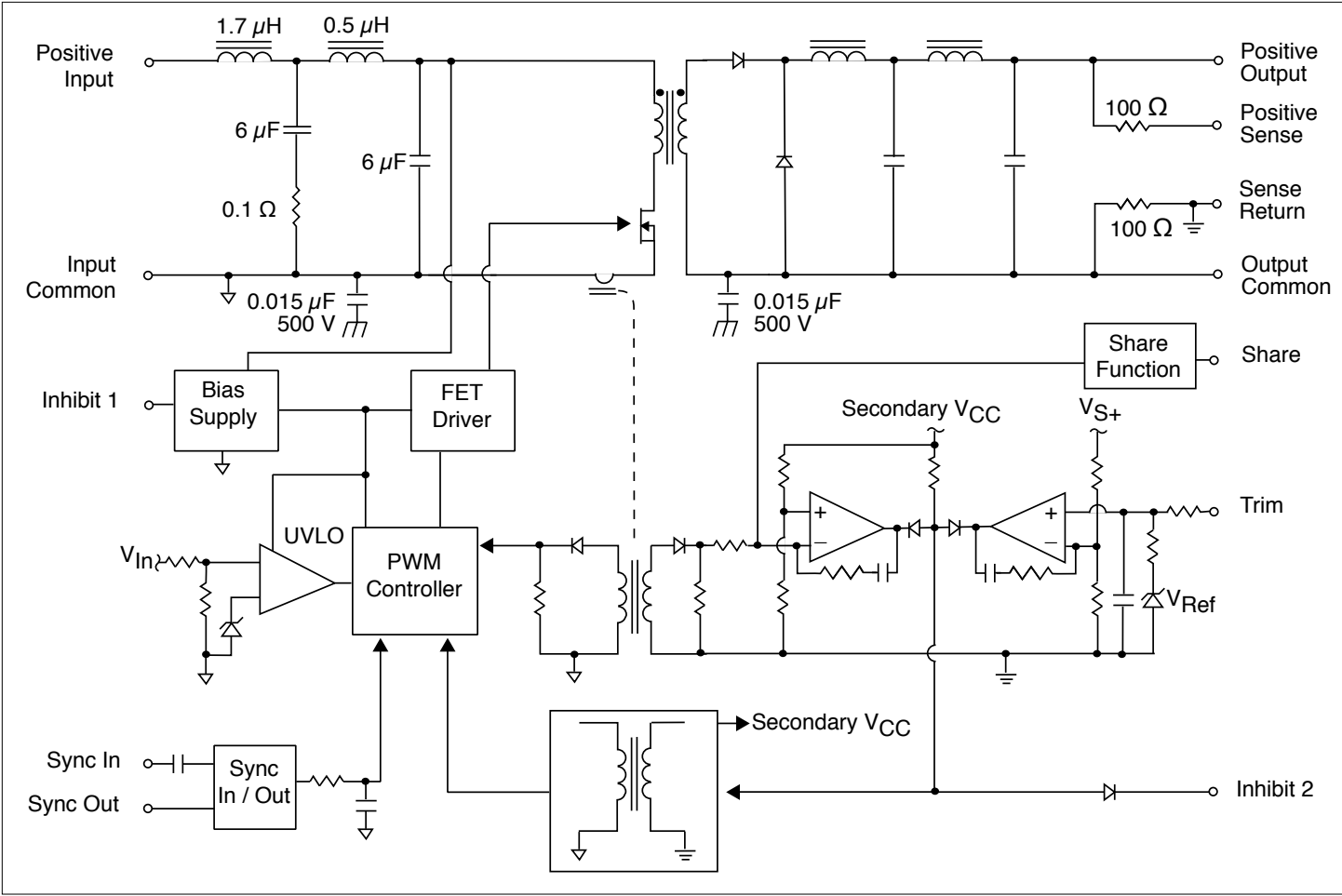

FIGURE 12: MOR SINGLE OUTPUT BLOCK DIAGRAM

MOR Single and Dual DC-DC Converters

28 VOLT INPUT – 120 WATT

PIN OUT		
Pin	Single Output	Dual Output
1	Positive Input	Positive Input
2	Input Common	Input Common
3	Trim	Case
4	Inhibit 1 (INH1)	Inhibit 1 (INH1)
5	Sync Out	Sync Out
6	Sync In	Sync In
7	Positive Output	Positive Output
8	Output Common	Output Common
9	Sense Return	Negative Output
10	Positive Sense	Trim
11	Share	Share
12	Inhibit 2 (INH2)	Inhibit 2 (INH2)

TABLE 1: PIN OUT

PINS NOT IN USE	
Case	User's discretion
Inhibit (INH1, INH2)	Leave unconnected
Sense Lines	Must be connected to the appropriate outputs
Sync In	Connect to input common
Sync Out	Leave unconnected
Share	Leave unconnected
Trim	Leave unconnected

TABLE 2: PINS NOT IN USE

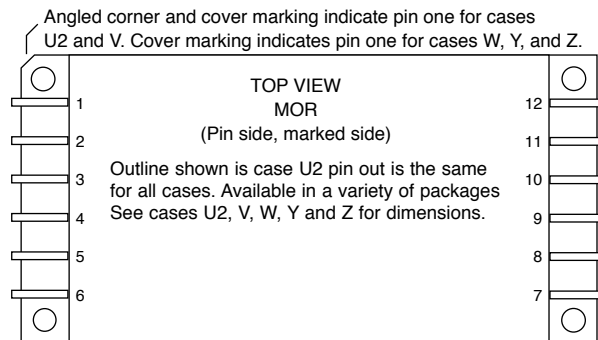

FIGURE 13: PIN OUT TOP VIEW

MOR Single and Dual DC-DC Converters

28 VOLT INPUT – 120 WATT

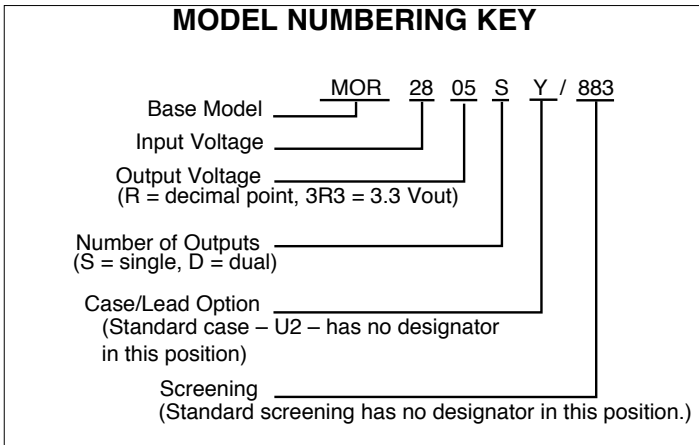

FIGURE 14: MODEL NUMBERING KEY

SMD NUMBERS	
STANDARD MICROCIRCUIT DRAWING (SMD)	MOR SIMILAR PART
5962-9954401HXC	MOR283R3S/883
5962-9954801HXC	MOR2805S/883
5962-9954501HXC	MOR286R3S/883
5962-9954601HXC	MOR289R5S/883
5962-9954901HXC	MOR2812S/883
5962-9955001HXC	MOR2815S/883
5962-9956401HXC	MOR283R3D/883
5962-9956101HXC	MOR2805D/883
5962-9956501HXC	MOR286R3D/883
5962-9956601HXC	MOR289R5D/883
5962-9956201HXC	MOR2812D/883
5962-9956301HXC	MOR2815D/883

The SMD number shown is for Class H screening, with an "X" case (standard U2 case). To indicate other case options, please refer to Table 4. For exact specifications for an SMD product, refer to the SMD drawing. SMDs can be downloaded from:
<https://landandmaritimeapps.dla.mil/programs/smcr>

TABLE 3: SMD CROSS REFERENCE

CASES: SMD AND SIMILAR PART NUMBER	
STANDARD MICROCIRCUIT DRAWING (SMD)	MOR SIMILAR PART
X	STANDARD CASE (U2)
U	V
T	W
Y	Y
Z	Z

TABLE 4: SMD CROSS REFERENCE FOR CASE OPTIONS

MODEL NUMBER OPTIONS					
TO DETERMINE THE MODEL NUMBER ENTER ONE OPTION FROM EACH CATEGORY IN THE FORM BELOW.					
CATEGORY	Base Model and Input Voltage	Output Voltage ¹	Number of Outputs ²	Case Options ³	Screening ⁴
OPTIONS	MOR28	3R3, 05, 6R3, 9R5, 12, 15	S D	(U2, leave blank) V, W, Y, Z	(standard, leave blank) ES 883
FILL IN FOR MODEL # ⁵	MOR28				/

- Notes
- Output Voltage: An R indicates a decimal point, 3R3 is 3.3 volts out.
 - Number of Outputs: S is a single output and D is a dual output. An R indicates a decimal, MOR283R3S has a 3.3 volt output.
 - Case Options: For the standard case, U2, leave the case option blank. For other case options, insert the letter that corresponds to the desired case. See Figure 55 through Figure 59 for case designators and dimensions.
 - Screening: For standard screening leave the screening option blank. For other screening options, insert the desired screening level. For more information see Table 11 on page 23 and Table 12 on page 24.
 - If ordering by model number add suffix "-Q" to request solder dipped leads (MOR2805S/883-Q). Available only for Class H.

TABLE 5: MODEL NUMBER OPTIONS

MOR Single and Dual DC-DC Converters

28 VOLT INPUT – 120 WATT

TABLE 6: OPERATING CONDITIONS, ALL MODELS, 25°C CASE, 28 VIN, 100% LOAD, UNLESS OTHERWISE SPECIFIED.

PARAMETER	CONDITIONS	ALL MODELS			UNITS
		MIN	TYP	MAX	
LEAD SOLDERING TEMPERATURE ¹	10 SECONDS MAX.	—	—	300	°C
STORAGE TEMPERATURE ¹		-65	—	+150	°C
CASE OPERATING TEMPERATURE	FULL POWER	-55	—	+125	°C
	ABSOLUTE ¹	-55	—	+135	
DERATING OUTPUT POWER/CURRENT ¹	LINEARLY	From 100% at 125°C to 0% at 135°C			
ISOLATION: INPUT TO OUTPUT OR ANY PIN TO CASE EXCEPT CASE PIN	@ 500 V AT 25°C	100	—	—	Megohms
UNDER VOLTAGE LOCKOUT		—	15.5	—	V
CURRENT LIMIT/POWER LIMIT ²	% OF FULL LOAD	—	125	—	%
AUDIO REJECTION ¹		—	40	—	dB
SWITCHING FREQUENCY		480	550	580	kHz
SYNCHRONIZATION	INPUT FREQUENCY	525	—	625	kHz
	DUTY CYCLE ¹	20	—	50	%
	ACTIVE LOW	—	—	0.8	V
	ACTIVE HIGH ¹	4.5	—	9	
	SYNC IN REFERENCED TO	INPUT COMMON			
	SYNC OUT REFERENCED TO	INPUT COMMON			
INHIBIT ACTIVE LOW (OUTPUT DISABLED) Do not apply a voltage to the inhibit pin. ³	INHIBIT 1 PIN PULLED LOW	—	—	0.8	V
	INHIBIT 1 PIN SOURCE CURRENT ¹	—	—	1	mA
	INHIBIT 1 REFERENCED TO	INPUT COMMON			
	INHIBIT 2 PIN PULLED LOW	—	—	0.2	V
	INHIBIT 2 PIN SOURCE CURRENT ¹	—	—	1	mA
	INHIBIT 2 SINGLES REFERENCED TO	SENSE RETURN			
	INHIBIT 2 DUALS REFERENCED TO	OUTPUT COMMON			
INHIBIT ACTIVE HIGH (OUTPUT ENABLED) Do not apply a voltage to the inhibit pin. ³	INHIBIT PIN CONDITION	OPEN COLLECTOR OR UNCONNECTED			
	INHIBIT 1 AND 2	UNCONNECTED			
	OPEN INHIBIT 1 PIN VOLTAGE ¹	—	13	—	V
	OPEN INHIBIT 2 PIN VOLTAGE ¹			8	

**For mean time between failures (MTBF) contact Applications Engineering
powerapps@craneae.com +1 425.882.3100 option 7**

Notes

1. Guaranteed by characterization test and/or analysis. Not a production test.
2. Current limit is defined as the point at which the output voltage drops by 1%.
Dual outputs: The over-current limit will trigger when the sum of the currents from both outputs reaches 125% (typical value) of the maximum rated "total" current of both outputs.

3. An external inhibit interface should be used to pull the inhibits low or leave them floating. The inhibit pins can be left unconnected if not used.

MOR Single and Dual DC-DC Converters

28 VOLT INPUT – 120 WATT

TABLE 7: ELECTRICAL CHARACTERISTICS -55°C TO +125°C CASE, 28 VIN, 100% LOAD, UNLESS OTHERWISE SPECIFIED.

SINGLE OUTPUT MODELS		MOR283R3S			MOR2805S			MOR286R3S			UNITS
PARAMETER	CONDITIONS	MIN	TYP	MAX	MIN	TYP	MAX	MIN	TYP	MAX	
OUTPUT VOLTAGE		3.22	3.30	3.38	4.87	5.00	5.13	6.17	6.30	6.43	V
OUTPUT CURRENT	$V_{IN} = 16$ to 40 V	0	—	20	0	—	20	0	—	16	A
OUTPUT POWER	$V_{IN} = 16$ to 40 V	0	—	66	0	—	100	0	—	100	W
OUTPUT RIPPLE	25°C	—	—	70	—	—	70	—	—	90	mV p-p
10 kHz - 20 MHz	-55°C TO +125°C	—	30	80	—	30	80	—	75	100	
LINE REGULATION	$V_{IN} = 16$ TO 40 V	—	0	20	—	0	20	—	0	20	mV
LOAD REGULATION	NO LOAD TO FULL	—	0	30	—	0	30	—	0	30	mV
INPUT VOLTAGE	CONTINUOUS	16	28	40	16	28	40	16	28	40	V
	TRANSIENT 120 ms	—	—	50	—	—	50	—	—	50	V
INPUT CURRENT	NO LOAD	—	70	150	—	70	150	—	70	150	mA
	INHIBITED-INH1	—	—	10	—	—	10	—	—	10	
	INHIBITED-INH2	—	—	70	—	—	70	—	—	70	
INPUT RIPPLE CURRENT	10 kHz - 20 MHz	—	40	90	—	50	130	—	50	130	mA p-p
EFFICIENCY	25°C	74	—	—	78	—	—	81	—	—	%
	-55°C TO +125°C	74	78	—	77	81	—	80	83	—	
LOAD FAULT ^{2, 3}	POWER DISSIPATION OVERLOAD ¹	—	27	—	—	30	—	—	30	—	W
	SHORT CIRCUIT	—	—	22	—	—	27	—	—	24	
	RECOVERY ¹	—	—	10	—	—	10	—	—	10	ms
STEP LOAD RESPONSE ^{3, 4}	50% - 100% - 50%										
	TRANSIENT	—	—	±250	—	—	±250	—	—	±500	mV pk
	RECOVERY	—	—	200	—	—	200	—	—	300	μs
STEP LINE RESPONSE ^{1, 3, 5}	16 - 40 - 16 V										
	TRANSIENT	—	—	±400	—	—	±400	—	—	±500	mV pk
	RECOVERY	—	—	300	—	—	300	—	—	300	μs
START-UP ^{3, 6}	DELAY	—	—	10	—	—	10	—	—	10	ms
	OVERSHOOT ¹	—	0	25	—	0	50	—	0	50	mV pk
CAPACITIVE LOAD ¹ $T_C = 25^\circ\text{C}$	NO EFFECT ON DC PERFORMANCE	—	—	1000	—	—	1000	—	—	1000	μF

Notes

- Guaranteed by characterization test and/or analysis. Not a production test.
- Short circuit is measured with a 10 milliohm ($\pm 10\%$) resistive load.
- Recovery and start-up times are measured from application of the transient or change in condition to the point at which V_{OUT} is within 1% of final value.

- Step load test is performed at 10 microseconds typical.
- Step line test is performed at 100 microseconds \pm 20 microseconds.
- Tested on release from inhibit.

MOR Single and Dual DC-DC Converters

28 VOLT INPUT – 120 WATT

TABLE 8: ELECTRICAL CHARACTERISTICS -55°C TO +125°C CASE, 28 VIN, 100% LOAD, UNLESS OTHERWISE SPECIFIED.

SINGLE OUTPUT MODELS		MOR289R5S			MOR2812S			MOR2815S			UNITS
PARAMETER	CONDITIONS	MIN	TYP	MAX	MIN	TYP	MAX	MIN	TYP	MAX	
OUTPUT VOLTAGE		9.31	9.50	9.69	11.76	12.00	12.24	14.70	15.00	15.30	V
OUTPUT CURRENT	$V_{IN} = 16$ to 40 V	0	—	11	0	—	9.2	0	—	8	A
OUTPUT POWER	$V_{IN} = 16$ to 40 V	0	—	105	—	—	110	—	—	120	W
OUTPUT RIPPLE 10 kHz - 20 MHz	25°C	—	—	100	—	—	100	—	—	130	mV p-p
	-55°C TO +125°C	—	75	120	—	75	120	—	75	150	
LINE REGULATION	$V_{IN} = 16$ TO 40 V	—	0	40	—	0	20	—	0	40	mV
LOAD REGULATION	NO LOAD TO FULL	—	0	95	—	0	100	—	0	100	mV
INPUT VOLTAGE	CONTINUOUS	16	28	40	16	28	40	16	28	40	V
	TRANSIENT 120 ms 1	—	—	50	—	—	50	—	—	50	V
INPUT CURRENT	NO LOAD	—	70	150	—	70	150	—	70	150	mA
	INHIBITED-INH1	—	—	10	—	—	10	—	—	10	
	INHIBITED-INH2	—	—	70	—	—	70	—	—	70	
INPUT RIPPLE CURRENT	10 kHz - 20 MHz	—	50	130	—	50	130	—	50	130	mA p-p
EFFICIENCY	25°C	81	—	—	84	—	—	84	—	—	%
	-55°C TO +125°C	80	84	—	83	86	—	83	87	—	
LOAD FAULT 2, 3	POWER DISSIPATION OVERLOAD 1	—	—	30	—	—	30	—	—	30	W
	SHORT CIRCUIT	—	—	24	—	—	22	—	—	20	
	RECOVERY 1	—	—	10	—	—	10	—	—	10	ms
STEP LOAD RESPONSE 3, 4	50% - 100% - 50%										
	TRANSIENT	—	—	±500	—	—	±600	—	—	±600	mV pk
	RECOVERY	—	—	300	—	—	300	—	—	300	μs
STEP LINE RESPONSE 1, 3, 5	16 - 40 - 16 V										
	TRANSIENT	—	—	±500	—	—	±600	—	—	±600	mV pk
	RECOVERY	—	—	300	—	—	300	—	—	300	μs
START-UP 3, 6	DELAY	—	—	10	—	—	10	—	—	10	ms
	OVERSHOOT 1	—	—	50	—	—	50	—	—	50	mV pk
CAPACITIVE LOAD 1 $T_C = 25^\circ\text{C}$	NO EFFECT ON DC										
	PERFORMANCE	—	—	1000	—	—	1000	—	—	1000	μF

Notes

1. Guaranteed by characterization test and/or analysis. Not a production test.
2. Short circuit is measured with a 10 milliohm ($\pm 10\%$) resistive load.
3. Recovery and start-up times are measured from application of the transient or change in condition to the point at which V_{OUT} is within 1% of final value.

4. Step load test is performed at 10 microseconds typical.
5. Step line test is performed at 100 microseconds ± 20 microseconds.
6. Tested on release from inhibit.

MOR Single and Dual DC-DC Converters

28 VOLT INPUT – 120 WATT

TABLE 9: ELECTRICAL CHARACTERISTICS -55°C TO +125°C CASE, 28 VIN, 100% LOAD, UNLESS OTHERWISE SPECIFIED.

DUAL OUTPUT MODELS		MOR283R3D			MOR2805D			MOR286R3D			UNITS
PARAMETER	CONDITIONS	MIN	TYP	MAX	MIN	TYP	MAX	MIN	TYP	MAX	
OUTPUT VOLTAGE ²	+V _{OUT}	3.20	3.30	3.40	4.875	5.00	5.125	6.17	6.30	6.43	V
	-V _{OUT}	3.16	3.30	3.44	4.82	5.00	5.18	6.12	6.30	6.48	
OUTPUT CURRENT ³ V _{IN} = 16 to 40 V	EITHER OUTPUT	—	±10	14 ¹	—	±10	14 ¹	—	±8	11.2 ¹	A
	TOTAL	—	—	20	—	—	20	—	—	16	
OUTPUT POWER ³ V _{IN} = 16 to 40 V	EITHER OUTPUT	—	±33	46 ¹	—	±50	70 ¹	—	±50	70 ¹	W
	TOTAL	—	—	66	—	—	100	—	—	100	
OUTPUT RIPPLE ±V _{OUT} 10 KHZ - 20 MHZ	25°C	—	—	70	—	—	75	—	—	90	mV p-p
	-55°C TO +125°C	—	50	80	—	50	80	—	50	100	
LINE REGULATION V _{IN} = 16 TO 40 V	+V _{OUT}	—	25	50	—	25	50	—	25	50	mV
	-V _{OUT}	—	50	100	—	50	100	—	50	100	
LOAD REGULATION	+V _{OUT}	—	25	50	—	25	50	—	25	50	mV
	-V _{OUT}	—	50	150	—	50	150	—	50	200	
CROSS REGULATION ^{1, 4}	-V _{OUT}	—	6	10	—	5	8	—	5	8	%
INPUT VOLTAGE	CONTINUOUS	16	28	40	16	28	40	16	28	40	V
	TRANSIENT 120 ms ¹	—	—	50	—	—	50	—	—	50	V
INPUT CURRENT	NO LOAD	—	70	160	—	70	160	—	70	160	mA
	INHIBITED-INH1	—	—	10	—	—	10	—	—	10	
	INHIBITED-INH2	—	—	70	—	—	70	—	—	70	
INPUT RIPPLE CURRENT	10 kHz - 20 MHz	—	60	90	—	60	130	—	—	130	mA p-p
EFFICIENCY	25°C	76	—	—	78	—	—	81	—	—	%
	-55°C TO +125°C	75	77	—	77	81	—	80	83	—	
LOAD FAULT ^{5, 6}	POWER DISSIPATION										W
	OVERLOAD ¹	—	—	27	—	—	30	—	—	30	
	SHORT CIRCUIT	—	—	22	—	—	27	—	—	24	
	RECOVERY ¹	—	—	10	—	—	10	—	—	10	
STEP LOAD RESPONSE ^{6, 7} ±V _{OUT} 50% - 100% - 50%	TRANSIENT	—	—	±250	—	—	±250	—	—	±500	mV pk
	RECOVERY	—	—	300	—	—	200	—	—	300	μs
STEP LINE RESPONSE ^{1, 6, 8} ±V _{OUT} 16 - 40 - 16 V	TRANSIENT	—	—	±400	—	—	±400	—	—	±500	mV pk
	RECOVERY	—	—	300	—	—	300	—	—	300	μs
START-UP ^{6, 9}	DELAY	—	—	10	—	—	10	—	—	10	ms
	OVERSHOOT ¹	—	—	25	—	—	50	—	—	50	mV pk
CAPACITIVE LOAD ^{1, 10} T _C = 25°C	NO EFFECT ON DC PERFORMANCE	—	—	1000	—	—	1000	—	—	1000	μF

Notes

- Guaranteed by characterization test and/or analysis. Not a production test.
- Output voltage for dual output models is measured with balanced loads.
- The "Total" specification is the maximum combined current/power of both outputs. Up to 70% of that total is available from either output provided the other output maintains a minimum of 30% of the total power used. The 15% minimum maintains regulation.
- Effect on negative Vout from 50%/50% loads to 70%/30% or 30%/70% loads.
- Short circuit is measured with a 10 milliohm (±10%) resistive load. Both outputs shorted simultaneously.
- Recovery and start-up times are measured from application of the transient or change in condition to the point at which V_{OUT} is within 1% of final value.
- Step load test is performed at 10 microseconds typical.
- Step line test is performed at 100 microseconds ± 20 microseconds.
- Tested on release from inhibit.
- Each output.

MOR Single and Dual DC-DC Converters

28 VOLT INPUT – 120 WATT

TABLE 10: ELECTRICAL CHARACTERISTICS -55°C TO +125°C CASE, 28 VIN, 100% LOAD, UNLESS OTHERWISE SPECIFIED.

DUAL OUTPUT MODELS		MOR289R5D			MOR2812D			MOR2815D			UNITS
PARAMETER	CONDITIONS	MIN	TYP	MAX	MIN	TYP	MAX	MIN	TYP	MAX	
OUTPUT VOLTAGE ²	+V _{OUT}	9.40	9.50	9.60	11.76	12.00	12.24	14.70	15.00	15.30	V
	-V _{OUT}	9.35	9.50	9.65	11.70	12.00	12.30	14.62	15.00	15.38	
OUTPUT CURRENT ³ V _{IN} = 16 to 40 V	EITHER OUTPUT	—	±5.53	7.75 ¹	—	±4.58	6.4 ¹	—	±4.00	5.6 ¹	A
	TOTAL	—	—	11.05	—	—	9.16	—	—	8	
OUTPUT POWER ³ V _{IN} = 16 to 40 V	EITHER OUTPUT	—	±52.5	73.5 ¹	—	±55	77 ¹	—	±60	84 ¹	W
	TOTAL	—	—	105	—	—	110	—	—	120	
OUTPUT RIPPLE ±V _{OUT} 10 KHZ - 20 MHZ	25°C	—	—	100	—	—	75	—	—	90	mV p-p
	-55°C TO +125°C	—	75	120	—	75	120	—	75	150	
LINE REGULATION V _{IN} = 16 TO 40 V	+V _{OUT}	—	25	50	—	25	50	—	25	50	mV
	-V _{OUT}	—	50	100	—	50	100	—	50	100	
LOAD REGULATION	+V _{OUT}	—	25	50	—	25	50	—	25	50	mV
	-V _{OUT}	—	50	200	—	50	200	—	50	200	
CROSS REGULATION ^{1, 4}	-V _{OUT}	—	4	7	—	3	5	—	2	4	%
INPUT VOLTAGE	CONTINUOUS	16	28	40	16	28	40	16	28	40	V
	TRANSIENT 120 ms ¹	—	—	50	—	—	50	—	—	50	V
INPUT CURRENT	NO LOAD	—	70	160	—	70	160	—	70	160	
	INHIBITED-INH1	—	—	10	—	—	10	—	—	10	mA
	INHIBITED-INH2	—	—	70	—	—	70	—	—	70	
INPUT RIPPLE CURRENT	10 kHz - 20 MHz	—	—	130	—	—	130	—	—	130	mA p-p
EFFICIENCY	25°C	82	—	—	84	—	—	85	—	—	%
	-55°C TO +125°C	80	84	—	82	86	—	83	87	—	
LOAD FAULT ^{5, 6}	POWER DISSIPATION OVERLOAD ¹	—	—	30	—	—	30	—	—	30	W
	SHORT CIRCUIT	—	—	24	—	—	22	—	—	20	
	RECOVERY ¹	—	—	10	—	—	10	—	—	10	ms
STEP LOAD RESPONSE ^{6, 7} ±V _{OUT} 50% - 100% - 50%	TRANSIENT	—	—	±500	—	—	±600	—	—	±600	mV pk
	RECOVERY	—	—	300	—	—	300	—	—	300	μs
STEP LINE RESPONSE ^{1, 6, 8} ±V _{OUT} 16 - 40 - 16 V	TRANSIENT	—	—	±600	—	—	±600	—	—	±750	mV pk
	RECOVERY	—	—	300	—	—	300	—	—	300	μs
START-UP ^{6, 9}	DELAY	—	—	10	—	—	10	—	—	10	ms
	OVERSHOOT ¹	—	—	50	—	—	25	—	—	50	mV pk
CAPACITIVE LOAD ^{1, 10} T _C = 25°C	NO EFFECT ON DC										
	PERFORMANCE	—	—	1000	—	—	1000	—	—	1000	μF

Notes

- Guaranteed by characterization test and/or analysis. Not a production test.
- Output voltage for dual output models is measured with balanced loads.
- The "Total" specification is the maximum combined current/power of both outputs. Up to 70% of that total is available from either output provided the other output maintains a minimum of 30% of the total power used. The 15% minimum maintains regulation.
- Effect on negative Vout from 50%/50% loads to 70%/30% or 30%/70% loads.

- Short circuit is measured with a 10 milliohm (±10%) resistive load. Both outputs shorted simultaneously.

- Recovery and start-up times are measured from application of the transient or change in condition to the point at which V_{OUT} is within 1% of final value.

- Step load test is performed at 10 microseconds typical.

- Step line test is performed at 100 microseconds ± 20 microseconds.

- Tested on release from inhibit.

- Each output.

MOR Single and Dual DC-DC Converters

28 VOLT INPUT – 120 WATT

TYPICAL PERFORMANCE PLOTS: 25°C CASE, 28 VIN, 100% LOAD, UNLESS OTHERWISE SPECIFIED. THESE ARE EXAMPLES FOR REFERENCE ONLY AND ARE NOT GUARANTEED SPECIFICATIONS.



MOR2812D
Sync Out Representative of all Models

FIGURE 15

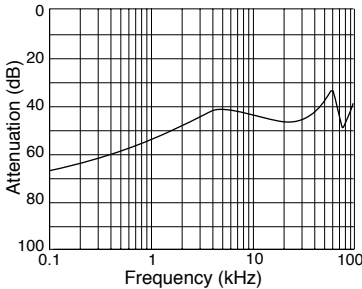

MOR2805S Audio Rejection

FIGURE 16

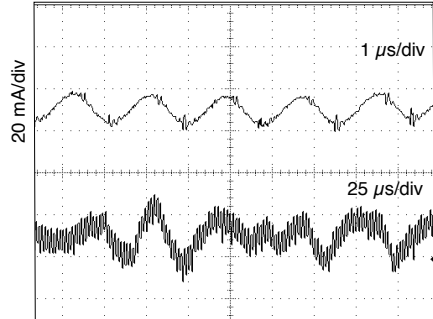

MOR2805S Input Ripple Current (lin)

FIGURE 17

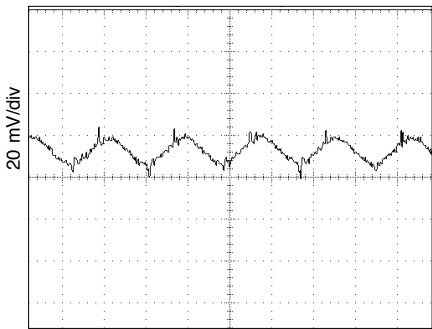

1 μs/div
80% Load
MOR2805S Output Ripple (Vout)

FIGURE 18

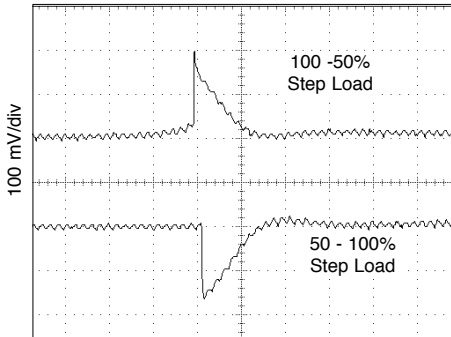

100 μs/div
MOR2805S Step Load Response

FIGURE 19

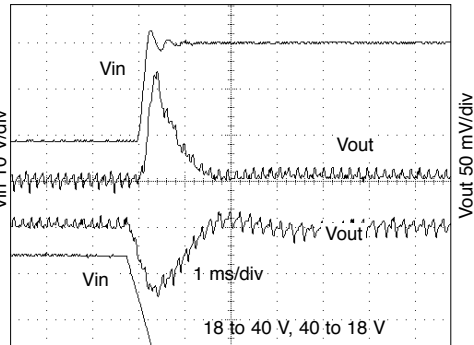

MOR2805S Step Line Response

FIGURE 20

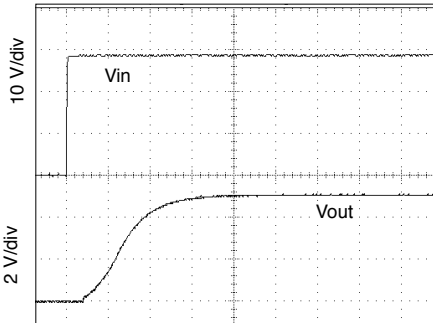

2.5 ms/div
All combinations of line and load
MOR2805S Start-up Response

FIGURE 21

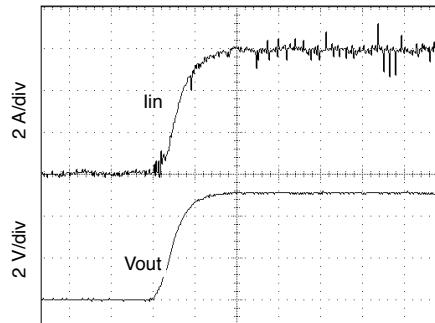

5 ms/div
With and without 470 μF cap. load
MOR2805S Inhibit Release Inrush Current

FIGURE 22

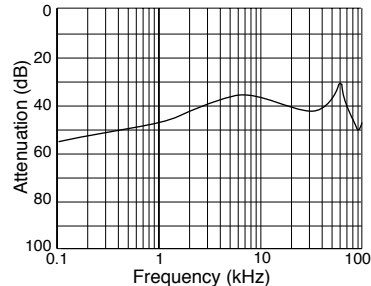

MOR2815S Audio Rejection

FIGURE 23

MOR Single and Dual DC-DC Converters

28 VOLT INPUT – 120 WATT

TYPICAL PERFORMANCE PLOTS: 25°C CASE, 28 VIN, 100% LOAD, UNLESS OTHERWISE SPECIFIED.
 THESE ARE EXAMPLES FOR REFERENCE ONLY AND ARE NOT GUARANTEED SPECIFICATIONS.

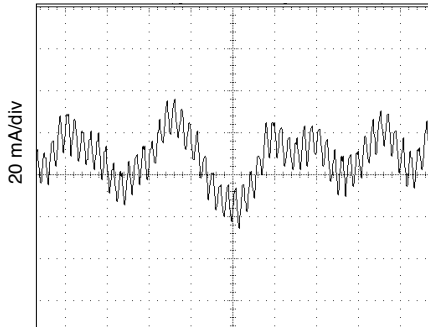

10 μ s/div
 MOR2815S Input Ripple (Iin)

FIGURE 24

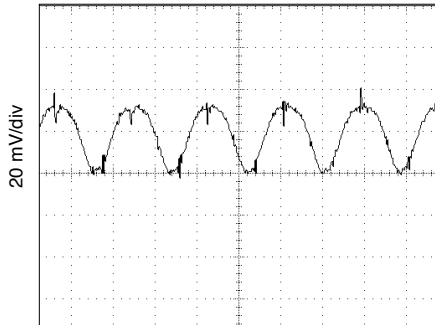

1 μ s/div
 MOR2815S Output Ripple (Vout)

FIGURE 25

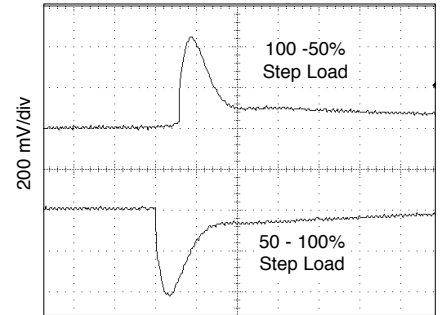

100 μ s/div
 MOR2815S Step Load Response

FIGURE 26

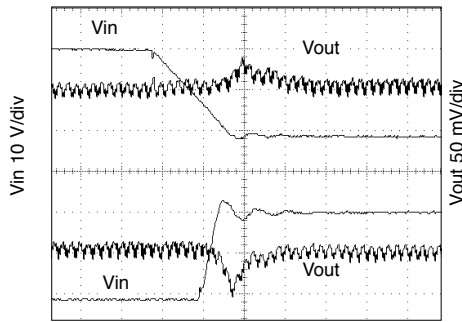

50 μ s/div
 18 to 40 V, 40 to 18 V, 50% load
 MOR2815S Step Line Response

FIGURE 27

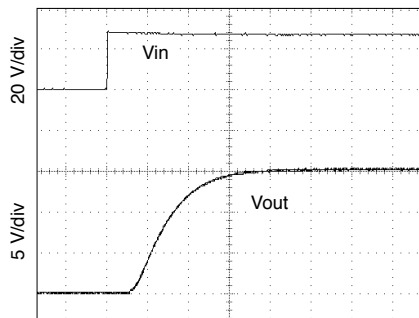

2.5 ms/div
 All combinations of line and load
 MOR2815S Start-up Response

FIGURE 28

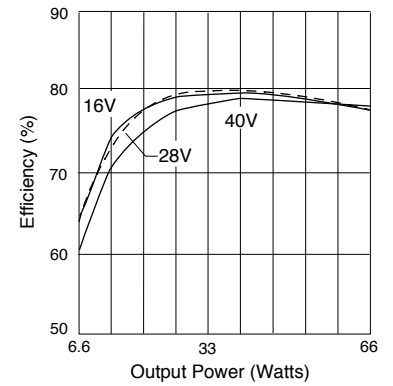

MOR283R3S Efficiency

FIGURE 29

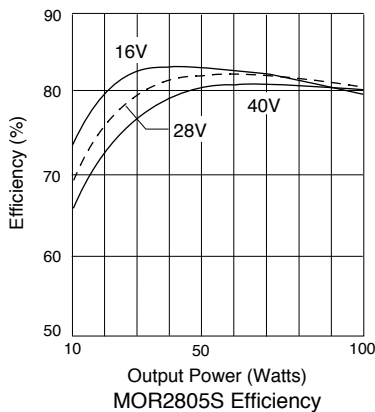

MOR2805S Efficiency

FIGURE 30

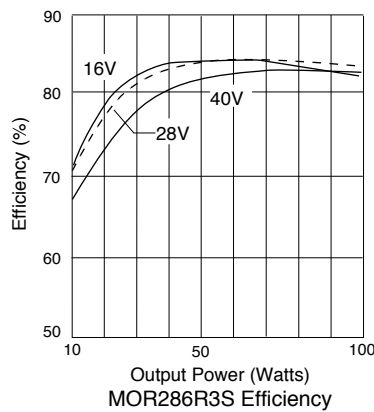

MOR286R3S Efficiency

FIGURE 31

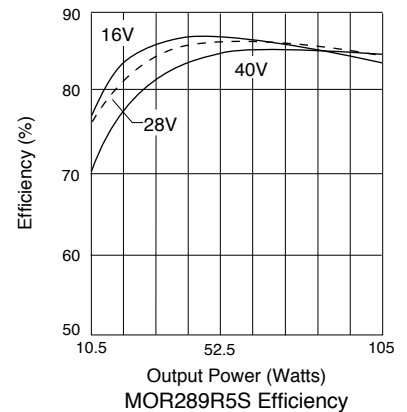

MOR289R5S Efficiency

FIGURE 32

MOR Single and Dual DC-DC Converters

28 VOLT INPUT – 120 WATT

TYPICAL PERFORMANCE PLOTS: 25°C CASE, 28 VIN, 100% LOAD, UNLESS OTHERWISE SPECIFIED. THESE ARE EXAMPLES FOR REFERENCE ONLY AND ARE NOT GUARANTEED SPECIFICATIONS.

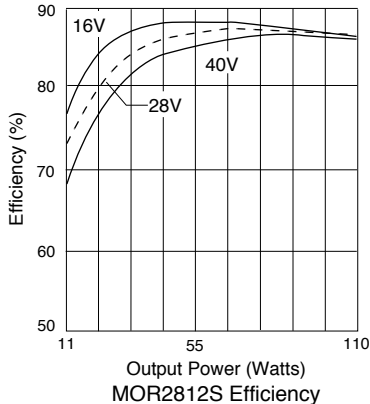

FIGURE 33

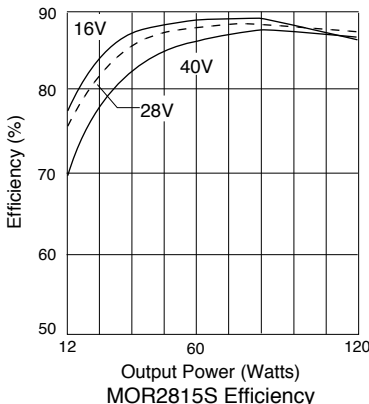
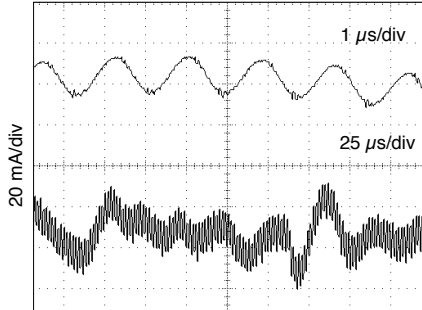
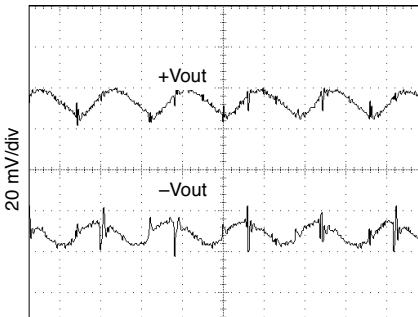

FIGURE 34



80% load each output
MOR2805D Input Ripple (lin)

FIGURE 35



80% load each output
MOR2805D Output Ripple (±Vout)

FIGURE 36

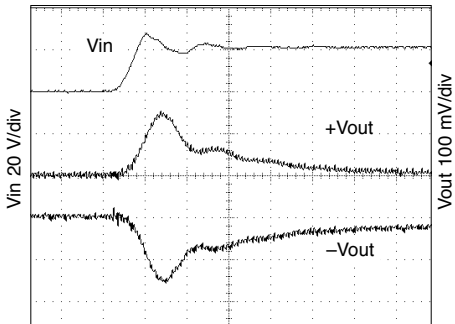

18 to 40 V, 80% load each output
MOR2805D Step Line Response

FIGURE 37

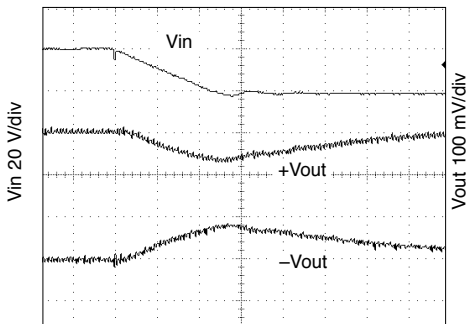

40 to 18 V, 80% load each output
MOR2805D Step Line Response

FIGURE 38

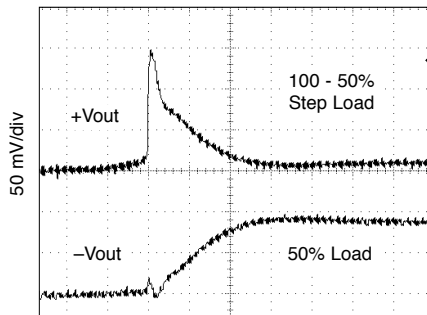

MOR2805D Step Load Response

FIGURE 39

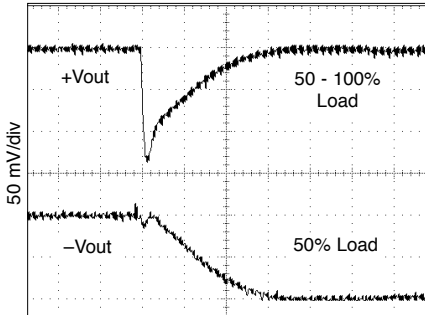

MOR2805D Step Load Response

FIGURE 40

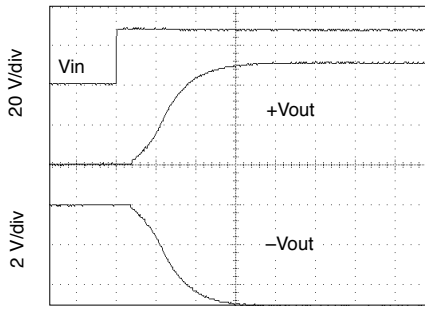

MOR2805D Start-up Response

FIGURE 41

MOR Single and Dual DC-DC Converters

28 VOLT INPUT – 120 WATT

TYPICAL PERFORMANCE PLOTS: 25°C CASE, 28 VIN, 100% LOAD, UNLESS OTHERWISE SPECIFIED. THESE ARE EXAMPLES FOR REFERENCE ONLY AND ARE NOT GUARANTEED SPECIFICATIONS.

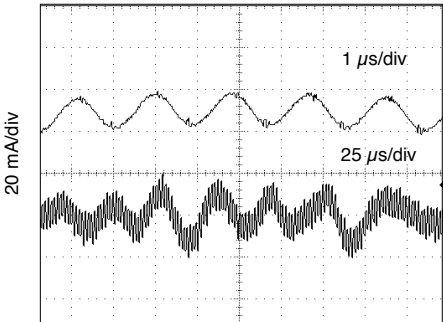

MOR2812D Input Ripple (lin)

FIGURE 42

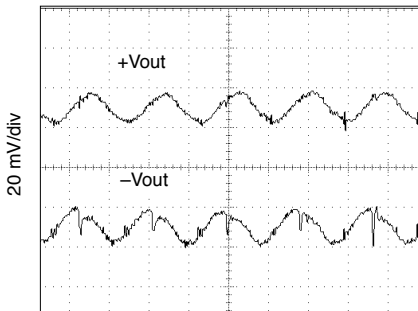

MOR2812D Output Ripple (±Vout)

FIGURE 43

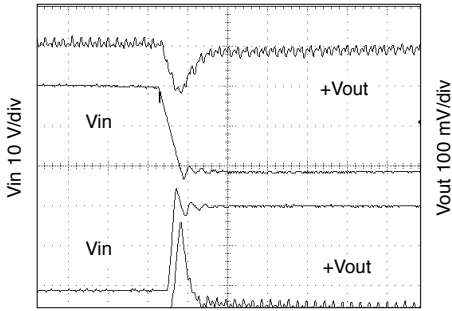

MOR2812D Step Line Response

FIGURE 44

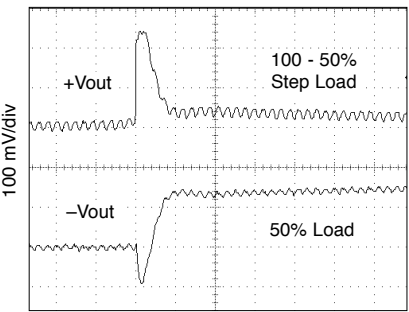

MOR2812D Step Load Response

FIGURE 45

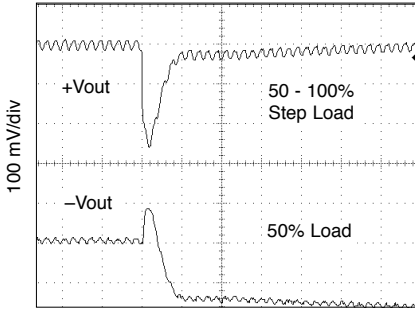

MOR2812D Step Load Response

FIGURE 46

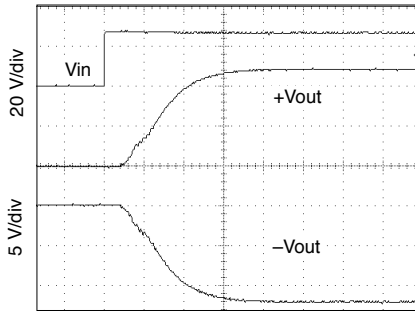

MOR2812D Start-up Response

FIGURE 47

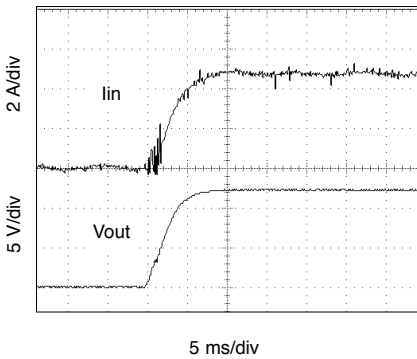

MOR2812D Inhibit Release Inrush Current

FIGURE 48

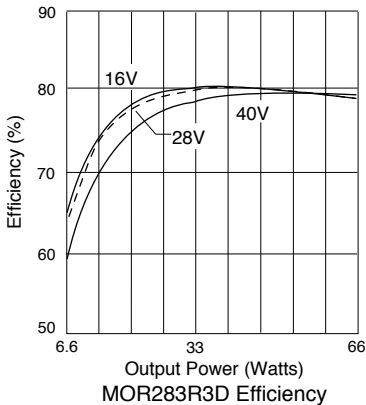

MOR283R3D Efficiency

FIGURE 49

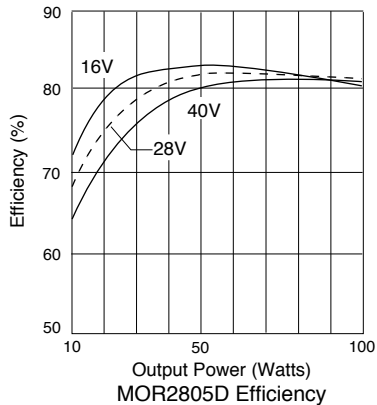

MOR2805D Efficiency

FIGURE 50

MOR Single and Dual DC-DC Converters

28 VOLT INPUT – 120 WATT

TYPICAL PERFORMANCE PLOTS: 25°C CASE, 28 VIN, 100% LOAD, UNLESS OTHERWISE SPECIFIED.
THESE ARE EXAMPLES FOR REFERENCE ONLY AND ARE NOT GUARANTEED SPECIFICATIONS.

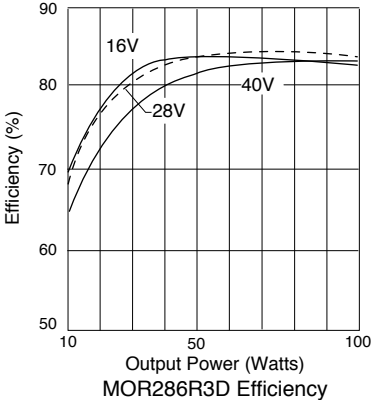

FIGURE 51

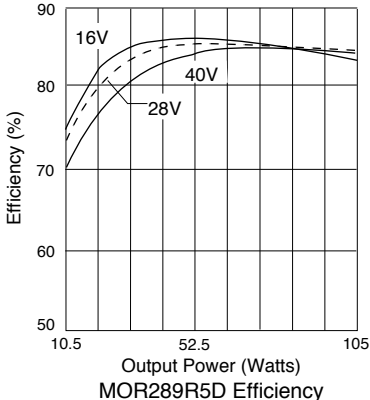

FIGURE 52

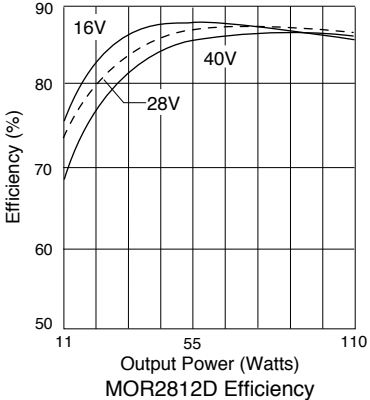

FIGURE 53

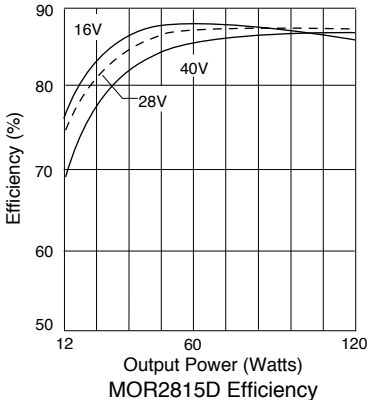

FIGURE 54

MOR Single and Dual DC-DC Converter Cases

28 VOLT INPUT – 120 WATT

TOP VIEW CASE U2 Flanged case, short leads

Case "U2" does not require a designator in the Case Option position of the model number for the MOR family

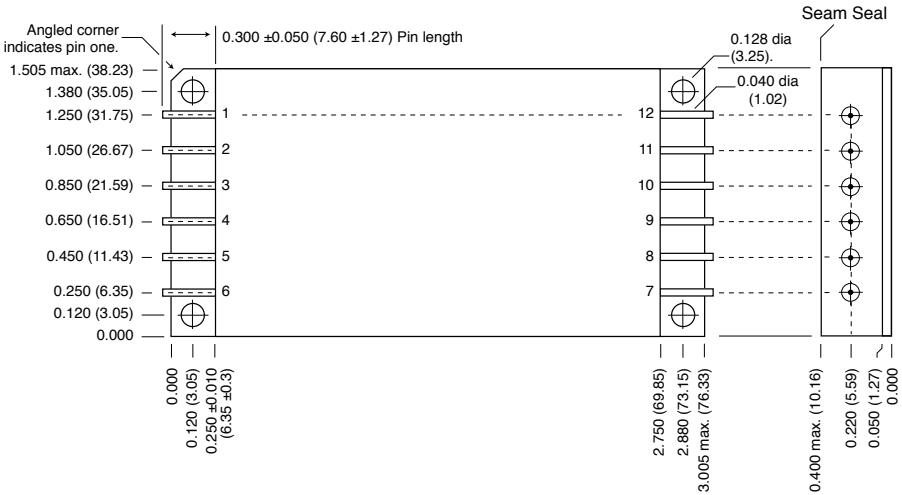

Weight: 82 grams maximum

Case dimensions in inches (mm)
Tolerance ±0.005 (0.13) for three decimal places
±0.01 (0.3) for two decimal places
unless otherwise specified

CAUTION
Heat from reflow or wave soldering may damage the device. Solder pins individually with heat application not exceeding 300°C for 10 seconds per pin.

Materials
Header Cold Rolled Steel/Nickel/Gold
Cover Kovar/Nickel
Pins OFHC copper/gold, compression glass seal
Gold plating of 50 - 150 microinches is included in pin diameter
Seal Hole: 0.120 ±0.002 (3.05 ±0.05)

Please refer to the numerical dimensions for accuracy.

FIGURE 55: CASE U2

MOR Single and Dual DC-DC Converter Cases

28 VOLT INPUT – 120 WATT

TOP VIEW CASE V Flanged case, down leaded

Case "V" requires a "V" in the Case Option position of the model number.

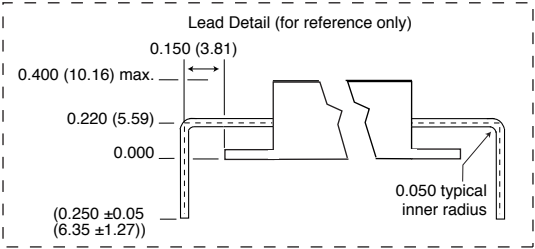
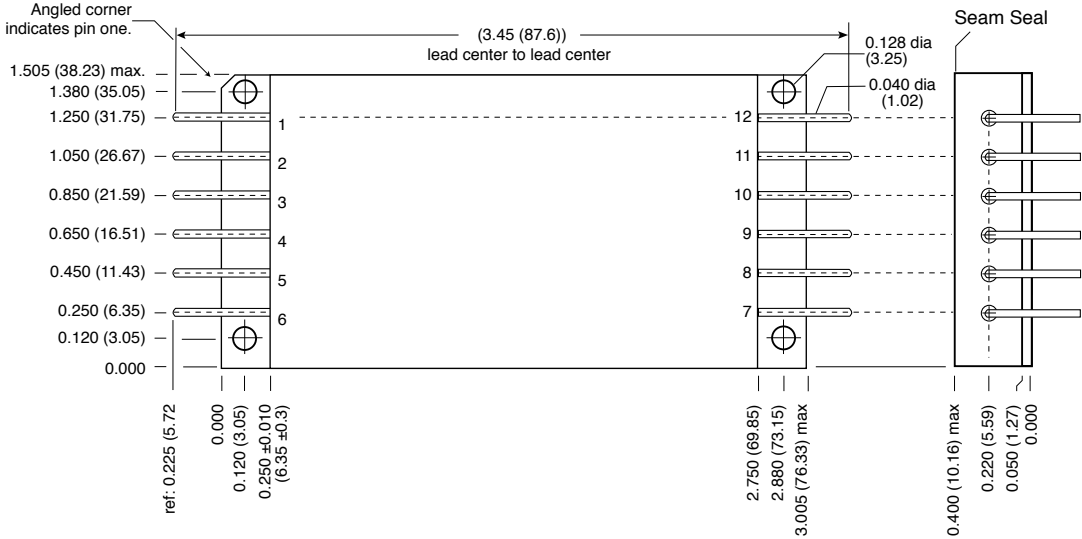

Weight: 84 grams maximum

Case dimensions in inches (mm)
 Tolerance ±0.005 (0.13) for three decimal places
 ±0.01 (0.3) for two decimal places
 unless otherwise specified

CAUTION
 Heat from reflow or wave soldering may damage the device. Solder pins individually with heat application not exceeding 300°C for 10 seconds per pin.

- Materials**
- Header Cold Rolled Steel/Nickel/Gold
 - Cover Kovar/Nickel
 - Pins OFHC copper/gold, compression glass seal
 - Gold plating of 50 - 150 microinches is included in pin diameter
 - Seal Hole: 0.120 ± 0.002 (3.05 ± 0.05)

Please refer to the numerical dimensions for accuracy.

FIGURE 56: CASE V

MOR Single and Dual DC-DC Converter Cases

28 VOLT INPUT – 120 WATT

TOP VIEW CASE W Tabbed case, up-leaded

Case "W" requires a "W" in the Case Option position of the model number.

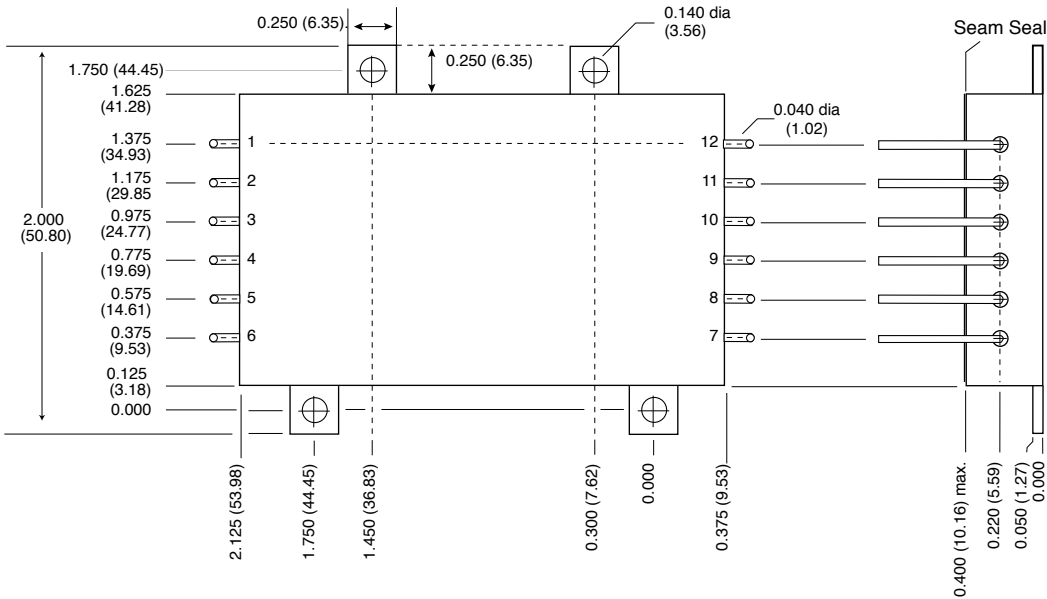

Weight: 79 grams maximum

Case dimensions in inches (mm)
 Tolerance ± 0.005 (0.13) for three decimal places
 ± 0.01 (0.3) for two decimal places
 unless otherwise specified

CAUTION
 Heat from reflow or wave soldering may damage the device.
 Solder pins individually with heat application not exceeding 300°C for 10 seconds per pin.

Materials
 Header Cold Rolled Steel/Nickel/Gold
 Cover Kovar/Nickel
 Pins OFHC copper/gold, compression glass seal
 Gold plating of 50 - 150 microinches
 Included in pin diameter
 Seal Hole: 0.120 ± 0.002 (3.05 ± 0.05)

Please refer to the numerical dimensions for accuracy.

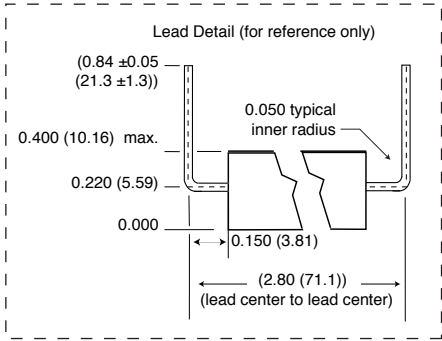

FIGURE 57: CASE W

MOR Single and Dual DC-DC Converter Cases

28 VOLT INPUT – 120 WATT

TOP VIEW CASE Y Tabbed case, straight-leaded

Case "Y" requires a "Y" in the Case Option position of the model number.

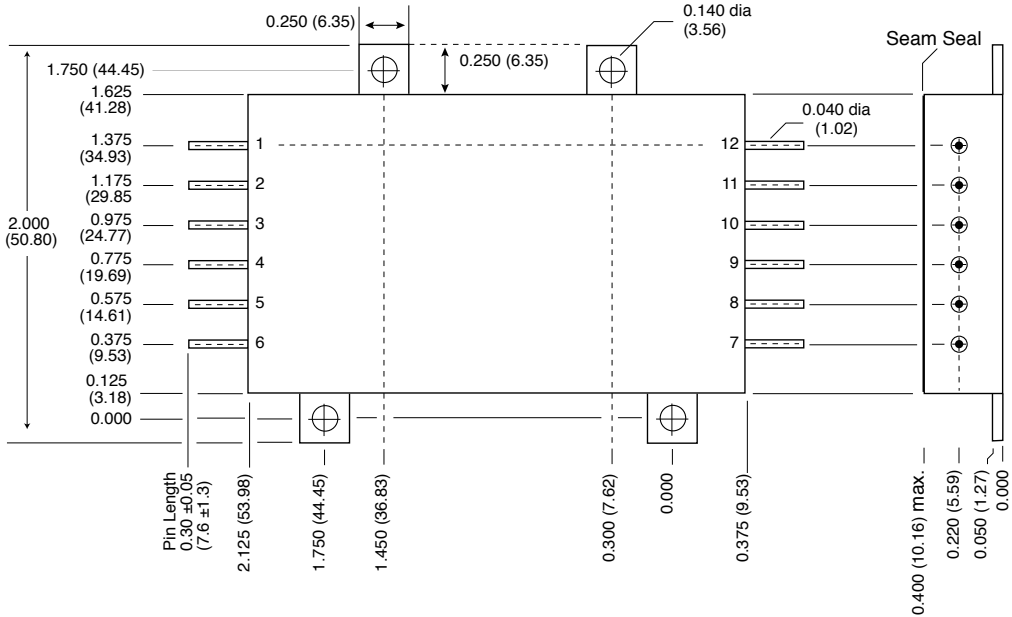

Weight: 79 grams maximum

Case dimensions in inches (mm)
 Tolerance ±0.005 (0.13) for three decimal places
 ±0.01 (0.3) for two decimal places
 unless otherwise specified

CAUTION
 Heat from reflow or wave soldering may damage the device.
 Solder pins individually with heat application not exceeding 300°C for 10 seconds per pin.

Materials
 Header Cold Rolled Steel/Nickel/Gold
 Cover Kovar/Nickel
 Pins OFHC copper/gold, compression glass seal
 Gold plating of 50 - 150 microinches
 Included in pin diameter
 Seal Hole: 0.120 ±0.002 (3.05 ±0.05)

Please refer to the numerical dimensions for accuracy.

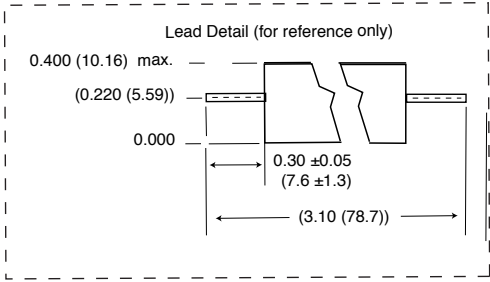

FIGURE 58: CASE Y

MOR Single and Dual DC-DC Converter Cases

28 VOLT INPUT – 120 WATT

TOP VIEW CASE Z Tabbed case, down-leaded

Case "Z" requires a "Z" in the Case Option position of the model number.

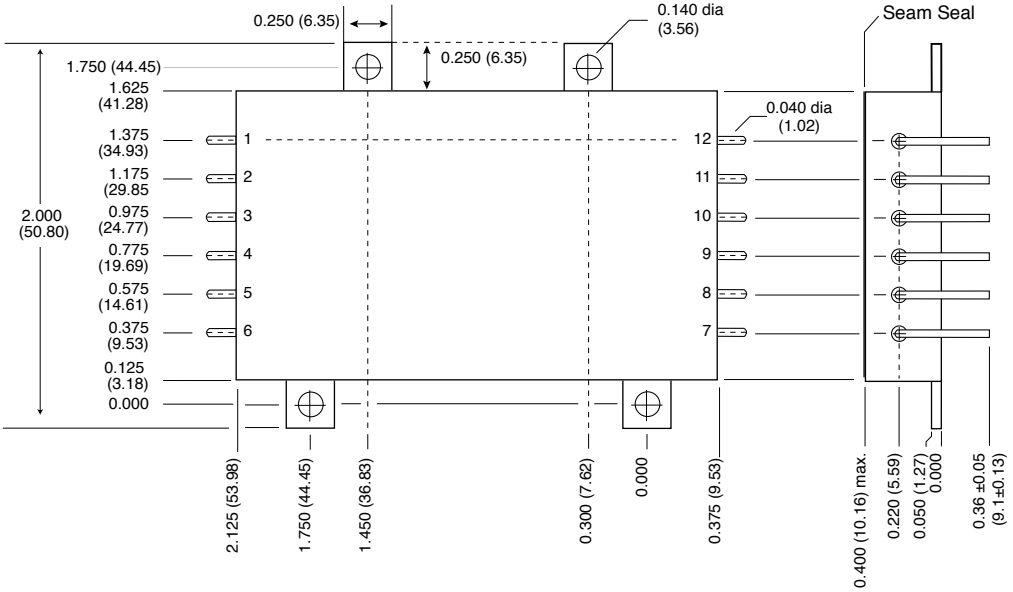

Weight: 79 grams maximum

Case dimensions in inches (mm)
 Tolerance ±0.005 (0.13) for three decimal places
 ±0.01 (0.3) for two decimal places
 unless otherwise specified

CAUTION
 Heat from reflow or wave soldering may damage the device.
 Solder pins individually with heat application not exceeding 300°C for 10 seconds per pin.

Materials
 Header Cold Rolled Steel/Nickel/Gold
 Cover Kovar/Nickel
 Pins OFHC copper/gold, compression glass seal
 Gold plating of 50 - 150 microinches
 Included in pin diameter
 Seal Hole: 0.120 ±0.002 (3.05 ±0.05)

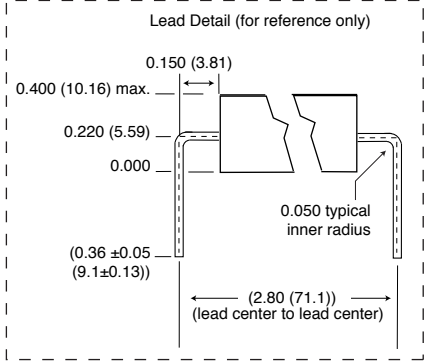

Please refer to the numerical dimensions for accuracy.

FIGURE 59: CASE Z

MOR Single and Dual DC-DC Converters

28 VOLT INPUT – 120 WATT

ELEMENT EVALUATION ¹ HIGH RELIABILITY /883 (CLASS H)

COMPONENT-LEVEL TEST PERFORMED	QML	
	CLASS H /883	
	M/S ²	P ³
Element Electrical	■	■
Visual	■	■
Internal Visual	■	
Final Electrical	■	■
Wire Bond Evaluation	■	■

Notes

1. Element evaluation does not apply to standard and /ES product.
2. M/S = Active components (microcircuit and semiconductor die).
3. P = Passive components, Class H element evaluation. Not applicable to standard and /ES element evaluation.

TABLE 11: ELEMENT EVALUATION

MOR Single and Dual DC-DC Converters

28 VOLT INPUT – 120 WATT

ENVIRONMENTAL SCREENING HIGH RELIABILITY STANDARD, /ES AND /883 (CLASS H)

TEST PERFORMED	NON-QML ¹		QML ²
	STANDARD	/ES	CLASS H /883
Pre-cap Inspection, Method 2017, 2032	■	■	■
Temperature Cycle (10 times)			
Method 1010, Cond. C, -65°C to +150°C, ambient			■
Method 1010, Cond. B, -55°C to +125°C, ambient		■	
Constant Acceleration			
Method 2001, 3000 g			■
Method 2001, 500 g		■	
PIND, Test Method 2020, Cond. A			■ ³
Burn-in Method 1015, +125°C case, typical ⁴			
96 hours		■	
160 hours			■
Final Electrical Test, MIL-PRF-38534, Group A,			
Subgroups 1 through 6, -55°C, +25°C, +125°C case			■
Subgroups 1 and 4, +25°C case	■	■	
Hermeticity Test			
Gross Leak, Cond. C ₁ , fluorocarbon		■	■
Fine Leak, Cond. A ₂ , helium		■	■
Gross Leak, Dip	■		
Final visual inspection, Method 2009	■	■	■

Test methods are referenced to MIL-STD-883 as determined by MIL-PRF-38534.

Notes

- Standard and ES are non-QML products and may not meet all of the requirements of MIL-PRF-38534.
- All processes are QML qualified and performed by certified operators.
- Not required by DLA but performed to assure product quality.
- Burn-in temperature designed to bring the case temperature to +125°C minimum.
Burn-in is a powered test.

TABLE 12: ENVIRONMENTAL SCREENING