

MHV Single, Dual and Triple DC-DC Converters

28 VOLT INPUT – 15 WATT

FEATURES

- No cross regulation on dual outputs
- Trim single output models from 110% to 80% depending on model
- Operating temperature -55°C to +125°C
- Input voltage range 16 to 50 volts
- Transient protection 80 V for 120 ms
- 12 V_{OUT} single and dual to 75 volts
- 15 V_{OUT} single and dual to 60 volts
- Fully isolated
- Fixed frequency switching
- Inhibit and sync functions
- Undervoltage lockout



MODELS		
OUTPUT VOLTAGE (V)		
SINGLE	DUAL	TRIPLE
3.3	±5	+5 & ±12
5	±12	+5 & ±15
12	±15	
15		

DESCRIPTION

The Interpoint® MHV Series™ of DC-DC converters offers up to 15 watts of power in a low profile package. The MHV converters are manufactured in our fully certified and qualified MIL-PRF-38534 Class H production facility and packaged in hermetically sealed steel cases. They are ideal for use in programs requiring high reliability, small size, and high efficiency. The series offers a wide input voltage range of 16 to 50 volts and a choice of nine different output voltage configurations comprised of single, dual or triple outputs. The 3.3 volt single, 5 volt single and dual and the triple output models will withstand transients of up to 80 volts for up to 120 milliseconds while maintaining output voltages. The 12 volt single and dual outputs will withstand transients up to 75 volts and the 15 volt single and dual outputs will withstand up to 60 volts for 120 milliseconds. The MHV Series operates at 15 watts of output power (10 watts for the 3.3 volt single output) over the military temperature range of -55°C to +125°C while maintaining low input and output noise.

CONVERTER DESIGN

MHV Series DC-DC converters are switching regulators that use continuous flyback conversion topology with a clock frequency of approximately 600 kHz. MHV Series converters incorporate two pulse width modulators (PWM) with one PWM phase shifted 180° from the other to create a dual phase/phase-shifted operation. Each of the PWMs operates at approximately one-half (300 kHz) of the clock frequency. This proprietary technology minimizes input ripple and improves efficiency. On singles the output ripple is reduced. Cross regulation is eliminated on dual output models which are independently regulated and do not require load balancing or minimum loading. On triple output models, this design provides completely independent regulation with no cross regulation effect between the main and auxiliary outputs and no minimum loading is required on the main output.

The dual models can be used as a single output voltage by connecting the load between positive and negative outputs, leaving the common unconnected, resulting in double the output voltage. (for example, MHV2815D can be used as a 30 volt output.) When using a dual to double the output voltage (span voltage) the maximum load capacitance across the span voltage is half that specified for each output.

INHIBIT FUNCTION

The converter is enabled when the inhibit terminal is left unconnected. When the inhibit terminal is pulled low (<0.8 V) the converter shuts down, typically drawing 8.4 mA at 28 V_{IN} or 15 mA at 50 V_{IN}. Sink current required is V_{IN} / 3.3 k ohm. For more information see Table 7 on page 7.

SYNCHRONIZATION FUNCTION

Applying an external signal of 40% to 60% duty cycle and 490 to 710 kHz for single and dual output models will synchronize the converter to your system requirements. For triple output models the external frequency range is 500 to 700 kHz. Free run clock frequency is approximately 600 kHz. If not used, the sync terminal must be left unconnected. See Table 7 on page 7

TRIM

Single output converters feature a trim range of as low as 80% to as high as 110% of V_{OUT} nominal, depending on the model. To trim up, connect a resistor from Output Common (pin 4) to Trim (pin 3). To trim down, connect a resistor from the Positive Output (pin 5) to Trim (pin 3). For more information see Table 1, Table 2 and Figure 6 on page 4.

MHV Single, Dual and Triple DC-DC Converters

28 VOLT INPUT – 15 WATT

SHORT CIRCUIT PROTECTION

Singles

The output current will be limited by approximately 140% of full load and can sustain indefinite short circuit protection. Restart is automatic upon removal of the short circuit.

Duals and Triples

The converter will limit the output power by decreasing the output voltage as the output current increases under conditions of approximately 180% of full load current for duals and 150% of full load current for triples. Short circuit duration should be brief to prevent excessive internal temperature rise. Restart is automatic upon removal of the short circuit.

UNDERVOLTAGE LOCKOUT

An undervoltage lockout of approximately 7 volts keeps system current levels low during startup. Low line dropout typically occurs at approximately $12 V_{IN}$ to $17 V_{IN}$ depending on model. See "Figure 13" and "Figure 14" on page 13 and "Figure 23" on page 14.

SCREENING

The converters are offered with standard screening, "ES" screening, or fully compliant to "883" MIL-PRF-38534 Class H screening. See Table 13 on page 20 and Table 14 on page 21. Standard microcircuit drawings (SMD) are available. See Table 5 on page 6.

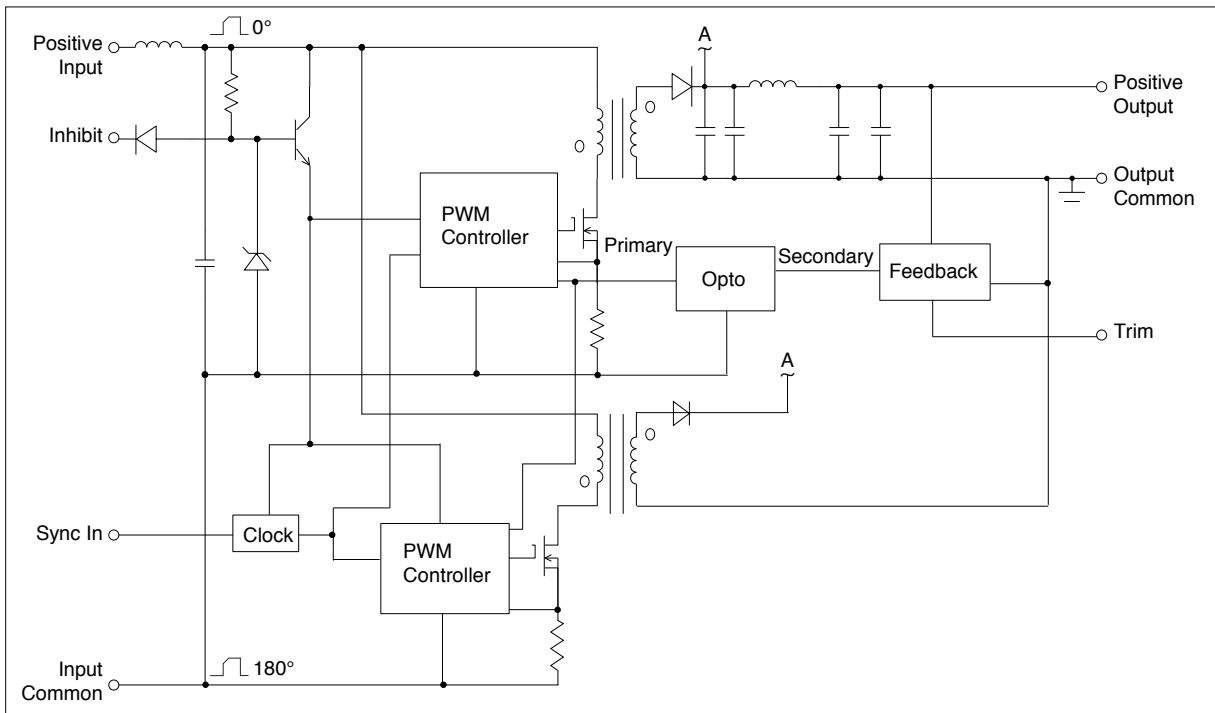

FIGURE 1: MHV SINGLE BLOCK DIAGRAM

MHV Single, Dual and Triple DC-DC Converters

28 VOLT INPUT – 15 WATT

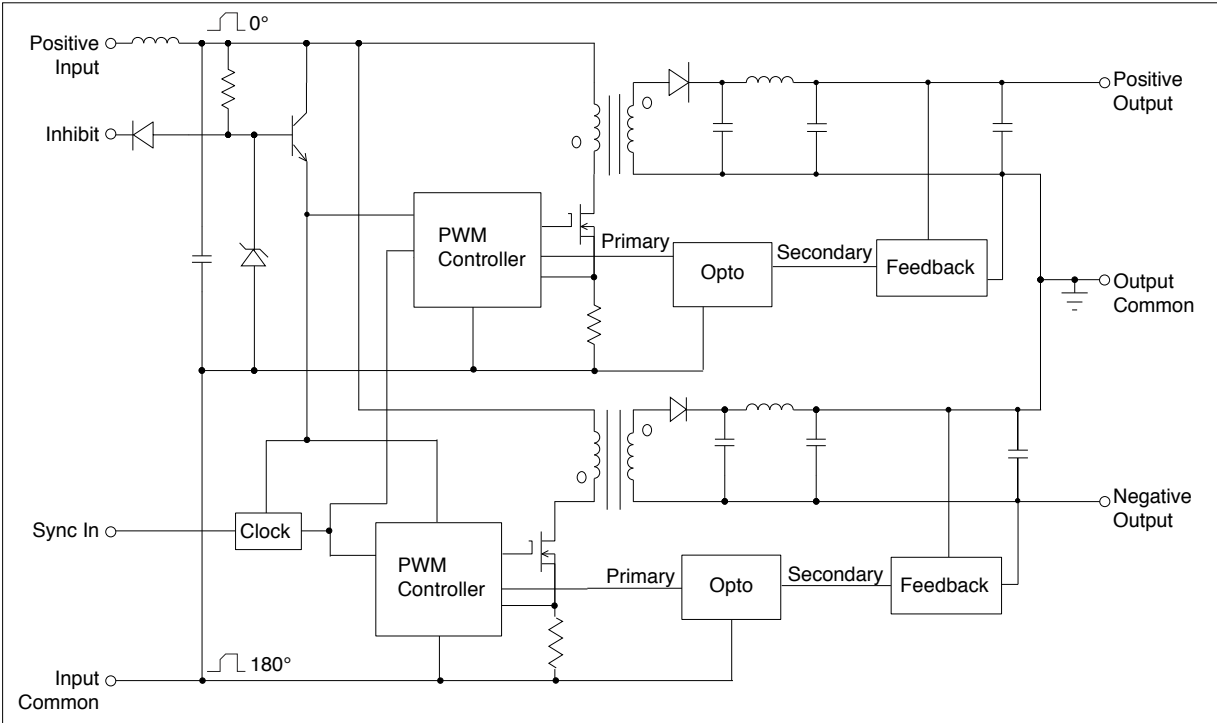

FIGURE 2: MHV DUAL BLOCK DIAGRAM

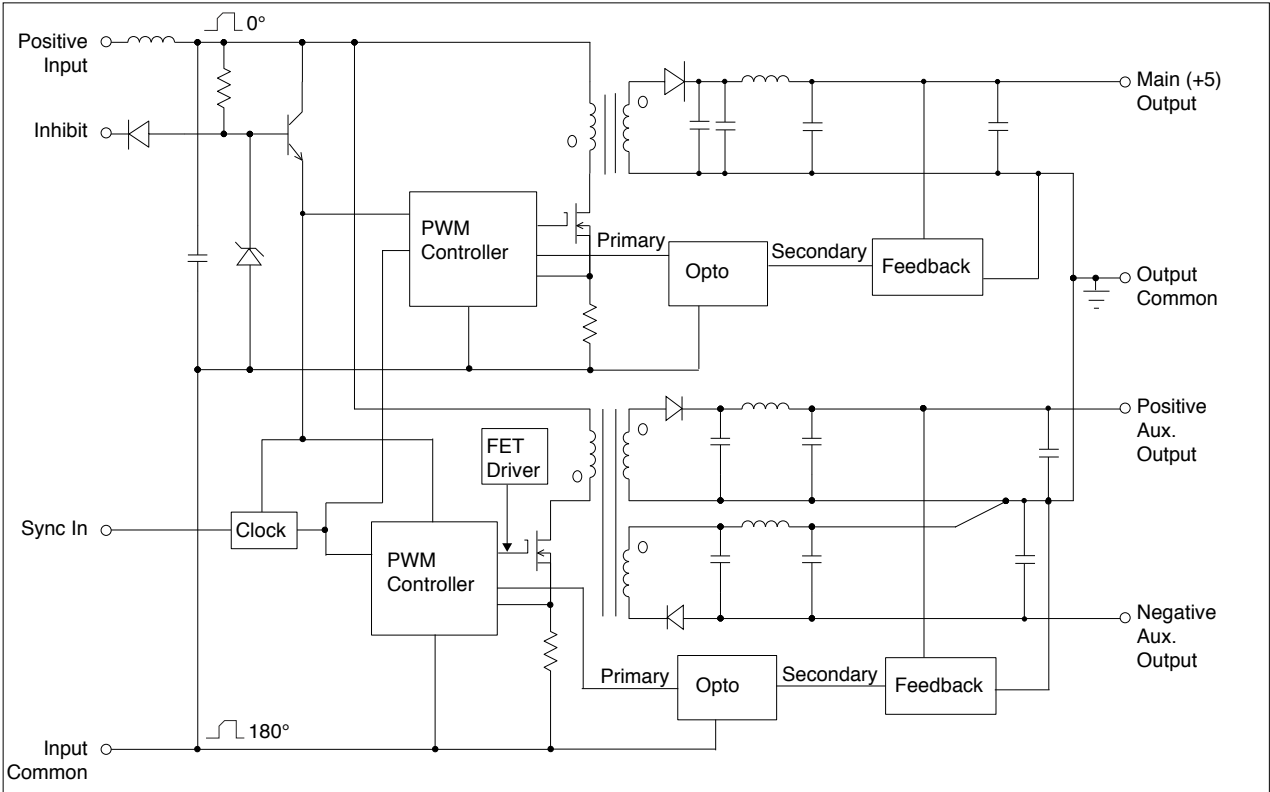

FIGURE 3: MHV TRIPLE BLOCK DIAGRAM

MHV Single, Dual and Triple DC-DC Converters

28 VOLT INPUT – 15 WATT

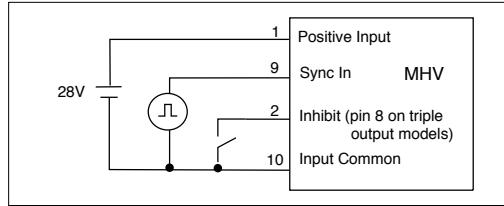

FIGURE 4: TYPICAL CONNECTIONS

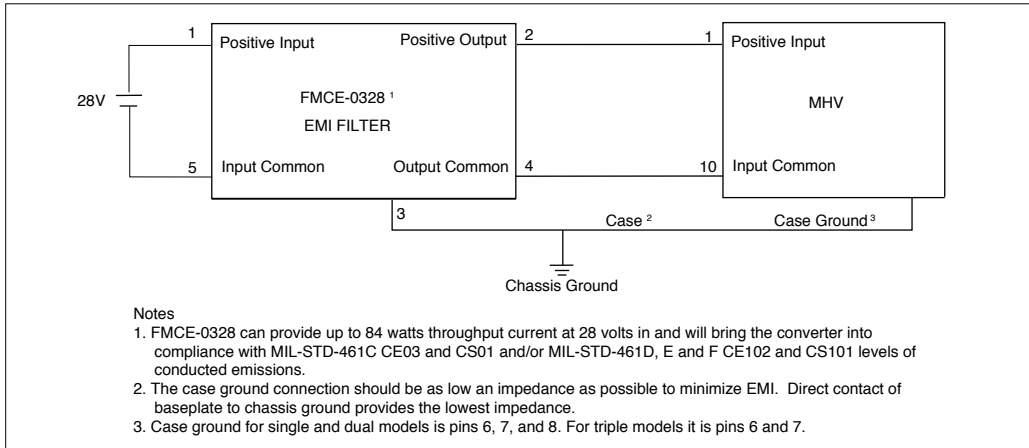

FIGURE 5: EMI FILTER CONNECTION

SINGLE OUTPUT TRIM

TRIM TABLE						
MODEL	V _{OUT} NOMINAL					
	110%	106%	102%	95%	90%	80%
R _{TRIM} (R _T) kΩ						
MHV283R3S	18	36	128	4	N/A	N/A
MHV2805S	8	20	81	23	5	N/A
MHV2812S	N/A	19	116	177	67	11
MHV2815S	0.3	21	122	255	104	28

TABLE 1: TRIM TABLE

$$\text{Trim down: } R_T \text{ (k}\Omega\text{)} = \left(\frac{V_o - 2.5}{V_o \text{ nominal} - V_o} \right) A - B$$

$$\text{Trim up: } R_T \text{ (k}\Omega\text{)} = \left(\frac{2.5 A}{V_o - V_o \text{ nominal}} \right) - B$$

V_O = desired output voltage

FORMULA 1: MHV SINGLE OUTPUT TRIM

FORMULA VALUE BY MODEL				
MODEL	3.3 V	5 V	12 V	15 V
A	3.7	3.7	14	18.2
B	10	10	30	30

TABLE 2: FORMULA VALUES BY MODEL

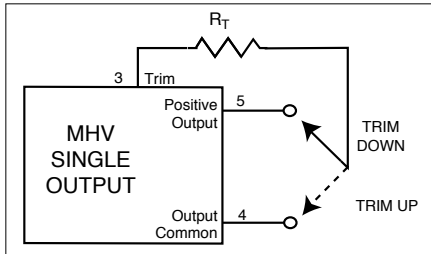

FIGURE 6: MHV SINGLE OUTPUT TRIM

Notes

If calculated result is a negative value, the desired output voltage is outside the allowed trim range.

Calculated values of R_T are ±15%.

When trimming up, do not exceed the maximum output power.

When trimming down, do not exceed the maximum output current.

MHV Single, Dual and Triple DC-DC Converters

28 VOLT INPUT – 15 WATT

PIN OUT			
Pin	Single Output	Dual Output	Triple Output
1	Positive Input	Positive Input	Positive Input
2	Inhibit	Inhibit	Main (+5) Output
3	Trim	Positive Output	Output Common
4	Output Common	Output Common	Negative Aux. Output
5	Positive Output	Negative Output	Positive Aux. Output
6, 7	Case Ground	Case Ground	Case Ground
8	Case Ground	Case Ground	Inhibit
9	Sync In	Sync In	Sync In
10	Input Common	Input Common	Input Common

TABLE 3: PIN OUT

PINS NOT IN USE	
Case	User discretion. For best EMI performance, connect to chassis ground.
Inhibit	Leave unconnected
Sync In	Leave unconnected

TABLE 4: PINS NOT IN USE

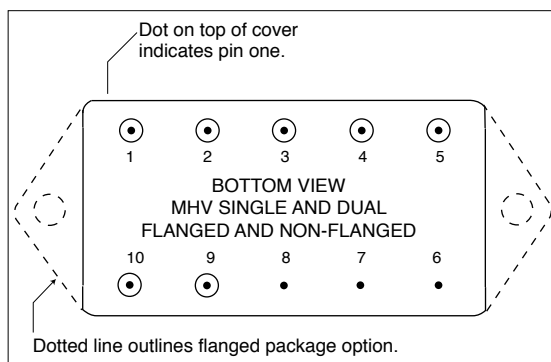

See Figure 30 on page 17 and Figure 32 on page 19 for dimensions.

FIGURE 7: PIN OUT SINGLES AND DUALS

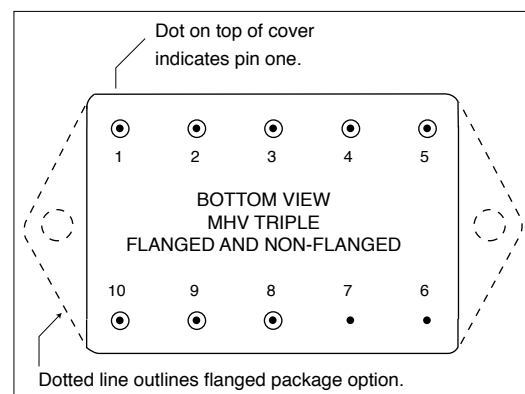

See Figure 29 on page 16 and Figure 31 on page 18 for dimensions.

FIGURE 8: PIN OUT TRIPLE

MHV Single, Dual and Triple DC-DC Converters

28 VOLT INPUT – 15 WATT

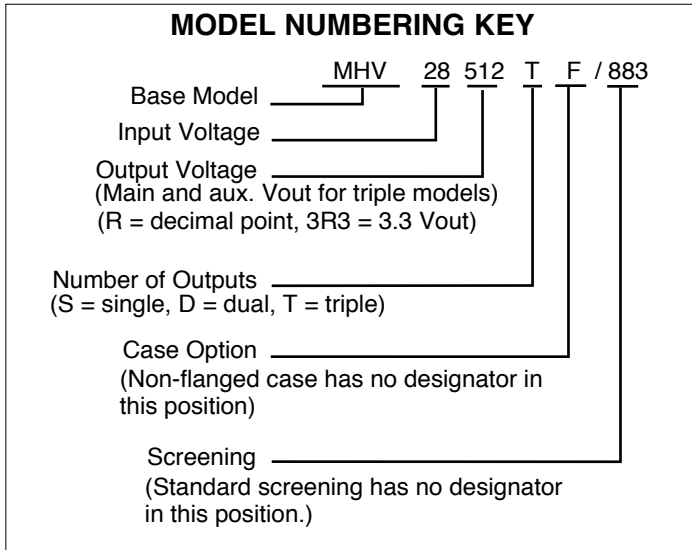

FIGURE 9: MODEL NUMBERING KEY

SMD NUMBERS	
STANDARD MICROCIRCUIT DRAWING (SMD)	MHV SIMILAR PART
5962-9852801HXC	MHV283R3S/883
5962-9852201HXC	MHV2805S/883
5962-9852301HXC	MHV2812S/883
5962-9852401HXC	MHV2815S/883
5962-9852501HXC	MHV2805D/883
5962-9852601HXC	MHV2812D/883
5962-9852701HXC	MHV2815D/883
5962-9673001HXC	MHV28512T/883
5962-9673101HXC	MHV28515T/883

Flanged SMDs have the suffix HZC instead of HXC.
 For exact specifications for an SMD product, refer to the SMD drawing. SMDs can be downloaded from <https://landandmaritimeapps.dla.mil/programs/smcr>

TABLE 5: SMD CROSS REFERENCE

MODEL NUMBER OPTIONS ¹					
TO DETERMINE THE MODEL NUMBER ENTER ONE OPTION FROM EACH CATEGORY IN THE FORM BELOW.					
CATEGORY	Base Model and Input Voltage	Output Voltage ²	Number of Outputs ³	Case Option ⁴	Screening ⁵
OPTIONS	MHV28	3R3, 05, 12, 15	S	(non-flanged, leave blank)	Standard (leave blank) /ES
		05, 12, 15	D		
		512, 515	T	F (flanged)	/883 (Class H)
FILL IN FOR MODEL # ⁶	MHV28	_____	_____	_____	/ _____

Notes

- See Figure 9, above, for an example of a model number.
- Output Voltage: An R indicates a decimal point. 3R3 is 3.3 volts out. The value of 3R3 is only available in single output models. The 512 and 515 triple output converters are +5 volt main and ±12 or ±15 volt auxiliaries.
- Number of Outputs: S is a single output, D is a dual output, and T is a triple output
- Case Options: For the standard case (non-flanged, Figure 30 on page 17 and Figure 29 on page 16) leave the case option blank. For the flanged case (Figure 32 on page 19 and Figure 31 on page 18) use an F in the case option.
- Screening: For standard screening leave the screening option blank. For other screening options, insert the desired screening level. For more information see Table 13 on page 20 and Table 14 on page 21.
- If ordering by model number add a “-Q” to request solder dipped leads (MHV28512TF/883-Q). Available only for Class H.

TABLE 6: MODEL NUMBER OPTIONS

MHV Single, Dual and Triple DC-DC Converters

28 VOLT INPUT – 15 WATT

TABLE 7: OPERATING CONDITIONS, ALL MODELS, 25°C CASE, 28 VIN, 100% LOAD, UNLESS OTHERWISE SPECIFIED.

PARAMETER	CONDITIONS	ALL MODELS			UNITS
		MIN	TYP	MAX	
LEAD SOLDERING TEMPERATURE ¹	10 SECONDS MAX.	–	–	300	°C
STORAGE TEMPERATURE ¹		-65	–	+150	°C
CASE OPERATING TEMPERATURE	FULL POWER	-55	–	+125	°C
	ABSOLUTE ¹	-55	–	+135	
DERATING OUTPUT POWER/CURRENT ¹	LINEARLY	From 100% at 125°C to 0% at 135°C			
ISOLATION: INPUT TO OUTPUT OR ANY PIN TO CASE EXCEPT CASE PIN	@ 500 VDC AT 25°C	100	–	–	Megohms
UNDER VOLTAGE LOCKOUT		–	7	–	V
LOW LINE DROPOUT ¹	DEPENDING ON MODEL	–	12-17	–	V
CURRENT LIMIT/POWER LIMIT ² % OF FULL LOAD	SINGLES	–	140	–	%
	DUALS	–	180	–	
	TRIPLES	–	150	–	
AUDIO REJECTION ¹		–	30	–	dB
CONVERSION FREQUENCY FREE RUN -55° TO +125°C	SINGLES AND DUALS	490	600	710	kHz
	TRIPLES	500	600	700	
SYNCHRONIZATION	INPUT FREQUENCY				kHz
	SINGLES AND DUALS	490	–	710	
	TRIPLES	500	–	700	
	DUTY CYCLE ¹	40	–	60	%
	ACTIVE LOW	–	–	0.8	V
	ACTIVE HIGH ¹	4.5	–	10	
	REFERENCED TO	INPUT COMMON			
IF NOT USED	LEAVE UNCONNECTED				
INHIBIT ACTIVE LOW (OUTPUT DISABLED) Do not apply a voltage to the inhibit pin. ^{3, 4}	INHIBIT PIN PULLED LOW	–	–	0.8	V
	INHIBIT PIN SOURCE CURRENT ¹	–	–	8.4	mA
	REFERENCED TO	INPUT COMMON			
INHIBIT ACTIVE HIGH (OUTPUT ENABLED) Do not apply a voltage to the inhibit pin. ³	INHIBIT PIN CONDITION	OPEN COLLECTOR OR UNCONNECTED			
	OPEN INHIBIT PIN VOLTAGE ¹	–	11	–	V

**For mean time between failures (MTBF) contact Applications Engineering
powerapps@cranae.com +1 425.882.3100 option 7**

Notes

1. Guaranteed by characterization test and/or analysis. Not a production test.
2. Current limit is defined as the point at which the output voltage decreases by 1%.
Singles limit the current to the value specified and have indefinite short circuit protection.

Duals and triples limit the power to the value specified. The output current will increase but the output voltage will decrease to prevent the output power from increasing. Due to the high currents the duals and triples do not have indefinite short circuit protection. Each output of the duals is independent. The auxiliary is independent from the main on the triples.

3. An external inhibit interface should be used to pull the inhibit low or leave it floating. The inhibit pin can be left unconnected if not used.

4. Sinking current required is $V_{IN} / 3.3 \text{ k}\Omega$.

MHV Single, Dual and Triple DC-DC Converters

28 VOLT INPUT – 15 WATT

TABLE 8: ELECTRICAL CHARACTERISTICS -55°C TO +125°C CASE, 28 VIN, 100% LOAD, UNLESS OTHERWISE SPECIFIED.

SINGLE OUTPUT MODELS		MHV283R3S			MHV2805S			UNITS
PARAMETER	CONDITIONS	MIN	TYP	MAX	MIN	TYP	MAX	
OUTPUT VOLTAGE		3.23	3.30	3.37	4.90	5.00	5.10	V
OUTPUT CURRENT	V _{IN} = 16 TO 50 V	0	—	3.03	0	—	3.00	A
OUTPUT POWER	V _{IN} = 16 TO 50 V	0	—	10	0	—	15	W
OUTPUT RIPPLE	T _C = 25°C	—	5	20	—	5	20	mV p-p
10 KHZ - 2 MHZ	TC = -55°C TO +125°C	—	—	25	—	—	25	
LINE REGULATION	V _{IN} = 16 TO 50 V	—	0	10	—	0	10	mV
LOAD REGULATION	NO LOAD TO FULL	—	15	35	—	15	45	mV
INPUT VOLTAGE	CONTINUOUS	16	28	50	16	28	50	V
NO LOAD TO FULL	TRANSIENT 120 ms ¹	—	—	80	—	—	80	V
INPUT CURRENT	NO LOAD	—	34	45	—	44	55	mA
	INHIBITED	—	8.4	10	—	8.4	10	
INPUT RIPPLE CURRENT	10 kHz - 10 MHz	—	10	45	—	10	40	mA p-p
EFFICIENCY	T _C = 25°C	69	72	—	74	77	—	%
	T _C = -55°C TO +125°C	68	—	—	73	—	—	
LOAD FAULT ^{2, 3}	POWER DISSIPATION	—	—	7.5	—	—	9	W
SHORT CIRCUIT	RECOVERY ¹	—	—	20	—	—	20	ms
STEP LOAD RESPONSE ^{3, 4}	TRANSIENT	—	—	±350	—	—	±350	mV pk
50% - 100% - 50%	RECOVERY	—	—	1.2	—	—	2	ms
STEP LINE RESPONSE ^{1, 3, 5}	TRANSIENT	—	—	±175	—	—	±550	mV pk
16 - 50 - 16 V	RECOVERY	—	—	0.90	—	—	2.0	ms
START-UP ^{3, 6}	DELAY	—	14	20	—	14	20	ms
	OVERSHOOT ¹	—	0	150	—	0	100	mV pk
CAPACITIVE LOAD ^{1, 7}	25°C	—	—	200	—	—	200	μF

Notes

1. Guaranteed by characterization test and/or analysis. Not a production test.
2. Load fault is a short circuit (<50 mΩ). Recovery is into a resistive load.
3. Recovery and start-up times are measured from application of the transient or change in condition to the point at which V_{OUT} is within 1% of final value.

4. Step load test is performed at 10 microseconds typical.
5. Step line test is performed at 100 microseconds ± 20 microseconds.
6. Tested on release from inhibit.
7. No effect on dc performance.

MHV Single, Dual and Triple DC-DC Converters

28 VOLT INPUT – 15 WATT

TABLE 9: ELECTRICAL CHARACTERISTICS -55°C TO +125°C CASE, 28 VIN, 100% LOAD, UNLESS OTHERWISE SPECIFIED.

SINGLE OUTPUT MODELS		MHV2812S			MHV2815S			UNITS
PARAMETER	CONDITIONS	MIN	TYP	MAX	MIN	TYP	MAX	
OUTPUT VOLTAGE		11.76	12.00	12.24	14.70	15.00	15.30	V
OUTPUT CURRENT	$V_{IN} = 16 \text{ TO } 50 \text{ V}$	0	—	1.25	0	—	1.00	A
OUTPUT POWER	$V_{IN} = 16 \text{ TO } 50 \text{ V}$	0	—	15	0	—	15	W
OUTPUT RIPPLE	$T_C = 25^\circ\text{C}$	—	5	20	—	5	20	mV p-p
10 kHz - 2 MHz	$T_C = -55^\circ\text{C TO } +125^\circ\text{C}$	—	—	25	—	—	25	
LINE REGULATION	$V_{IN} = 16 \text{ TO } 50 \text{ V}$	—	1	12	—	4	15	mV
LOAD REGULATION	NO LOAD TO FULL	—	8	35	—	10	40	mV
INPUT VOLTAGE	CONTINUOUS	16	28	50	16	28	50	V
NO LOAD TO FULL	TRANSIENT 120 ms ¹	—	—	75	—	—	60	V
INPUT CURRENT	NO LOAD	—	43	58	—	45	65	mA
	INHIBITED	—	8.4	10	—	8.4	10	
INPUT RIPPLE CURRENT	10 kHz - 10 MHz	—	10	40	—	10	40	mA p-p
EFFICIENCY	$T_C = 25^\circ\text{C}$	79	81	—	78	81	—	%
	$T_C = -55^\circ\text{C TO } +125^\circ\text{C}$	78	—	—	76	—	—	
LOAD FAULT ^{2, 3}	POWER DISSIPATION	—	—	7.5	—	—	7.5	W
SHORT CIRCUIT	RECOVERY ¹	—	—	20	—	—	20	ms
STEP LOAD RESPONSE ^{3, 4}	TRANSIENT	—	—	±400	—	—	±550	mV pk
50% - 100% - 50%	RECOVERY	—	—	1.5	—	—	1.5	
STEP LINE RESPONSE ^{1, 3, 5}	TRANSIENT	—	—	±550	—	—	±650	mV pk
16 - 50 - 16 V	RECOVERY	—	—	2.5	—	—	2.5	
START-UP ^{3, 6}	DELAY	—	14	20	—	14	20	ms
	OVERSHOOT ¹	—	0	240	—	0	300	mV pk
CAPACITIVE LOAD ^{1, 7}	25°C	—	—	200	—	—	200	μF

Notes

1. Guaranteed by characterization test and/or analysis. Not a production test.
2. Load fault is a short circuit (<50 mΩ). Recovery is into a resistive load.
3. Recovery and start-up times are measured from application of the transient or change in condition to the point at which V_{OUT} is within 1% of final value.

4. Step load test is performed at 10 microseconds typical.
5. Step line test is performed at 100 microseconds ± 20 microseconds.
6. Tested on release from inhibit.
7. No effect on dc performance.

MHV Single, Dual and Triple DC-DC Converters

28 VOLT INPUT – 15 WATT

TABLE 10: ELECTRICAL CHARACTERISTICS -55°C TO +125°C CASE, 28 VIN, 100% LOAD, UNLESS OTHERWISE SPECIFIED.

DUAL OUTPUT MODELS		MHV2805D			MHV2812D			MHV2815D			UNITS
PARAMETER	CONDITIONS	MIN	TYP	MAX	MIN	TYP	MAX	MIN	TYP	MAX	
OUTPUT VOLTAGE	±V _{OUT}	4.90	5.00	5.10	11.76	12.00	12.24	14.70	15.00	15.30	V
OUTPUT CURRENT	EITHER OUTPUT	0	—	1.5	0	—	0.625	0	—	0.50	A
VIN = 16 TO 50 V	TOTAL	—	—	3	—	—	1.25	—	—	1.0	
OUTPUT POWER ²	EITHER OUTPUT	0	—	7.5	0	—	7.5	0	—	7.5	W
VIN = 16 TO 50 V	TOTAL	—	—	15	—	—	15	—	—	15	
OUTPUT RIPPLE	TC = 25°C	—	5	30	—	5	20	—	10	40	mV p-p
±V _{OUT} , 10 kHz - 2 MHz	TC = -55°C TO +125°C	—	—	35	—	—	25	—	—	50	
LINE REGULATION BALANCED LOADS	VIN = 16 TO 50 V	—	0	10	—	0	10	—	0	10	mV
LOAD REGULATION	NO LOAD TO FULL	—	5	20	—	2	20	—	2	20	mV
INPUT VOLTAGE	CONTINUOUS ³	16	28	50	16	28	50	16	28	50	V
NO LOAD TO FULL	TRANSIENT 120 ms ¹	—	—	80	—	—	75	—	—	60	V
INPUT CURRENT	NO LOAD	—	22	30	—	32	43	—	37	50	mA
	INHIBITED	—	8.4	10	—	8.4	10	—	8.4	10	
INPUT RIPPLE CURRENT	10 kHz - 10 MHz	—	5	40	—	5	40	—	10	45	mA p-p
EFFICIENCY	TC = 25°C	77	79	—	81	83	—	80	83	—	%
	TC = -55°C TO +125°C	75	—	—	79	—	—	78	—	—	
LOAD FAULT ^{3, 4, 5}	POWER DISSIPATION	—	—	8.5	—	—	10	—	—	10	W
SHORT CIRCUIT	RECOVERY ¹	—	—	20	—	—	25	—	—	30	ms
STEP LOAD RESPONSE ^{5, 6}	50% - 100% - 50% TRANSIENT	—	—	±350	—	—	±400	—	—	±500	mV pk
	RECOVERY	—	—	3.0	—	—	1.5	—	—	1.5	ms
STEP LINE RESPONSE ^{1, 5, 7}	TRANSIENT	—	—	±400	—	—	±500	—	—	±500	mV pk
16 - 50 - 16 V _{IN} ±V _{OUT}	RECOVERY	—	—	4.0	—	—	3.0	—	—	3.0	ms
START-UP ^{3, 5, 8}	+V _{OUT} DELAY	—	10	18	—	10	20	—	12	22	ms
	-V _{OUT} DELAY	—	10	20	—	10	25	—	12	30	
	OVERSHOOT ¹	—	0	100	—	0	240	—	0	300	
CAPACITIVE LOAD ^{1, 9}	TC = 25°C	—	—	100	—	—	100	—	—	100	μF

Notes

1. Guaranteed by characterization test and/or analysis. Not a production test.
2. Up to 7.5 watts is available from either output.
3. At inputs above 40 volts with temperatures above approximately 100°C, to ensure start-up, transition time should be greater than 5 ms and use of the inhibit function should be avoided.
4. Load fault is a short circuit (<50 mΩ). Recovery is into a resistive load.

5. Recovery and start-up times are measured from application of the transient or change in condition to the point at which V_{OUT} is within 1% of final value.
6. Step load test is performed at 10 microseconds typical.
7. Step line test is performed at 100 microseconds ± 20 microseconds.
8. Tested on release from inhibit.
9. Applicable to each output. No effect on dc performance.

MHV Single, Dual and Triple DC-DC Converters

28 VOLT INPUT – 15 WATT

TABLE 11: ELECTRICAL CHARACTERISTICS -55°C TO +125°C CASE, 28 VIN, 100% LOAD, UNLESS OTHERWISE SPECIFIED.

TRIPLE OUTPUT MODEL – MHV28512T		5 (MAIN)			±12 (AUXILIARIES)			UNITS
PARAMETER	CONDITIONS	MIN	TYP	MAX	MIN	TYP	MAX	
OUTPUT VOLTAGE	MAIN AND POS. AUX	4.90	5.00	5.10	11.76	12.00	12.24	V
	NEG. AUX.				-11.70	-12.00	-12.30	
OUTPUT CURRENT ²		0	—	2.0	0	±0.208	0.333 ¹	A
V _{IN} = 16 TO 50 V	MAX TOTAL AUX	—	—	—	—	—	0.416	
OUTPUT POWER ³		0	—	10	0	±2.50	4.00 ¹	W
V _{IN} = 16 TO 50 V	MAX TOTAL AUX	—	—	—	—	—	5	
OUTPUT RIPPLE	T _C = 25°C	—	8	20	—	9	20	mV p-p
	±V _{OUT} , 10 KHZ - 2 MHZ	T _C = -55°C TO +125°C	—	—	22	—	—	
LINE REGULATION	MAIN AND POS. AUX	—	0	5	—	5	35	mV
	V _{IN} = 16, 50 V	NEG. AUX.	—	—	—	—	7	
LOAD REGULATION ⁴	MAIN AND POS. AUX	—	10	20	—	10	30	mV
		NEG. AUX.	—	—	—	—	40	
CROSS REGULATION ⁵	EFFECT ON NEGATIVE AUXILIARY	—	—	—	—	400	800	mV
INPUT VOLTAGE	CONTINUOUS ⁶	16	28	50	—	—	—	V
		TRANSIENT 120 ms ¹	—	—	80	—	—	—
INPUT CURRENT	NO LOAD	—	30	37	—	—	—	mA
		INHIBITED	—	8.4	10	—	—	
INPUT RIPPLE CURRENT	10 kHz - 10 MHz	—	10	30	—	—	—	mA p-p
EFFICIENCY	T _C = 25°C	75	78	—	—	—	—	%
		T _C = -55°C TO +125°C	74	—	—	—	—	
LOAD FAULT ^{6, 7, 8}	POWER DISSIPATION	—	—	9.5	—	—	9.5	W
		RECOVERY ¹	—	—	25	—	—	25
STEP LOAD RESPONSE ^{8, 9}	TRANSIENT	—	—	±350	—	—	±600	mV pk
		RECOVERY	—	—	3	—	—	4
STEP LINE RESPONSE ^{1, 8, 10}	TRANSIENT	—	—	±400	—	—	±500	mV pk
		RECOVERY	—	—	3	—	—	4
START-UP ^{6, 8, 11}	DELAY	—	7	15	—	7	15	ms
		OVERSHOOT ¹	—	—	100	—	—	240
CAPACITIVE LOAD ^{1, 12}	25°C	—	—	200	—	—	100	μF

Notes

- Guaranteed by characterization test and/or analysis. Not a production test.
- The sum of the 12 volt auxiliary output currents may not exceed 416 mA.
- The sum of the auxiliary output power may not exceed 5 watts. Up to 80% of the total power (5W) is available from either auxiliary providing the opposite auxiliary is carrying 20% of the total auxiliary power used.
- Load regulation for the +5 is specified at 0.0 to 2.0 A with the aux. both held at 2.5 W (208 mA). Load regulation for the auxiliary is specified as both auxiliaries from 0.0 to 2.5 W (208 mA) at the same time with the +5 held at 2.0 A.
- Cross regulation occurs between the two auxiliaries and is measured on -aux. +5 is held constant at 2.0 A. Cross regulation is specified for two conditions:
 - Positive aux. = 2.5 W (50%); negative aux. = 2.5 W to 0.5 W (50% to 10%).
 - From +Po = 70% and -Po = 30% to + Po = 30% and -Po = 70%.
 Above conditions are referenced to 50%/50% balanced loads.
- At inputs above 40 volts with temperatures above approximately 100°C, to ensure start-up, transition time should be greater than 5 ms and use of the inhibit function should be avoided.
- Load fault is a short circuit (<50 mΩ). Recovery is into a resistive load.
- Recovery and start-up times are measured from application of the transient or change in condition to the point at which V_{OUT} is within 1% of final value.
- Step load test is performed at 10 microseconds typical.
- Step line test is performed at 100 microseconds ± 20 microseconds.
- Tested on release from inhibit.
- Applicable to each output. No effect on dc performance.

MHV Single, Dual and Triple DC-DC Converters

28 VOLT INPUT – 15 WATT

TABLE 12: ELECTRICAL CHARACTERISTICS -55°C TO +125°C CASE, 28 VIN, 100% LOAD, UNLESS OTHERWISE SPECIFIED.

TRIPLE OUTPUT MODEL – MHV28515T		5 (MAIN)			±15 (AUXILIARIES)			UNITS
PARAMETER	CONDITIONS	MIN	TYP	MAX	MIN	TYP	MAX	
OUTPUT VOLTAGE	MAIN AND POS. AUX	4.90	5.00	5.10	14.70	15.00	15.30	V
	NEG. AUX.				-14.62	-15.00	-15.38	
OUTPUT CURRENT ² VIN = 16 TO 50 V		—	—	2.0	0	±0.167	0.267 ¹	A
	TOTAL	—	—	—	—	—	0.333	
OUTPUT POWER ³ VIN = 16 TO 50 V		0	—	10	0	±2.50	4.00 ¹	W
	TOTAL	—	—	—	—	—	5	
OUTPUT RIPPLE ±VOUT, 10 KHZ - 2 MHZ	TC = 25°C	—	8	20	—	9	20	mV p-p
	TC = -55°C TO +125°C	—	—	22	—	—	22	
LINE REGULATION VIN = 16, 50 V	MAIN AND POS. AUX	—	0	5	—	7	35	mV
	NEG. AUX.				—	7	40	
LOAD REGULATION ⁴	MAIN AND POS. AUX	—	10	20	—	10	30	mV
	NEG. AUX.	—	—	—	—	40	80	
CROSS REGULATION ⁵	EFFECT ON NEGATIVE AUXILIARY	—	—	—	—	400	800	mV
INPUT VOLTAGE	CONTINUOUS ⁶	16	28	50	—	—	—	V
	TRANSIENT 120 ms ¹	—	—	80	—	—	—	V
INPUT CURRENT	NO LOAD	—	34	41	—	—	—	mA
	INHIBITED	—	8.4	10	—	—	—	
INPUT RIPPLE CURRENT	10 kHz - 10 MHz	—	10	30	—	—	—	mA p-p
EFFICIENCY	TC = 25°C	75	78	—	—	—	—	%
	TC = -55°C TO +125°C	74	—	—	—	—	—	
LOAD FAULT ^{6, 7, 8}	POWER DISSIPATION	—	—	9.5	—	—	9.5	W
	RECOVERY ¹	—	—	25	—	—	25	ms
STEP LOAD RESPONSE ^{8, 9}	TRANSIENT	—	—	±350	—	—	±600	mV pk
	RECOVERY	—	—	3	—	—	4	ms
STEP LINE RESPONSE ^{1, 8, 10} 16 - 50 - 16 VIN	TRANSIENT	—	—	±400	—	—	±500	mV pk
	RECOVERY	—	—	3	—	—	4	ms
START-UP ^{6, 8, 11}	DELAY	—	—	15	—	—	15	ms
	OVERSHOOT ¹	—	—	100	—	—	300	mV pk
CAPACITIVE LOAD ^{1, 12}	25°C	—	—	200	—	—	100	μF

Notes

- Guaranteed by characterization test and/or analysis. Not a production test.
- The sum of the 15 volt auxiliary output currents may not exceed 333 mA.
- The sum of the auxiliary output power may not exceed 5 watts. Up to 80% of the total power (5W) is available from either auxiliary providing the opposite auxiliary is carrying 20% of the total auxiliary power used.
- Load regulation for the +5 is specified at 0.0 to 2.0 A with the aux. both held at 2.5 W (167 mA). Load regulation for the auxiliary is specified as both auxiliaries from 0.0 to 2.5 W (167 mA) at the same time with the +5 held at 2.0 A.
- Cross regulation occurs between the two auxiliaries and is measured on -aux. +5 is held constant at 2.0 A. Cross regulation is specified for two conditions:
 - Positive aux. = 2.5 W (50%); negative aux. = 2.5 W to 0.5 W (50% to 10%).
 - From +Po = 70% and -Po = 30% to + Po = 30% and -Po = 70%.
 Above conditions are referenced to 50%/50% balanced loads.
- At inputs above 40 volts with temperatures above approximately 100°C, to ensure start-up, transition time should be greater than 5 ms and use of the inhibit function should be avoided.
- Load fault is a short circuit (<50 mΩ). Recovery is into a resistive load.
- Recovery and start-up times are measured from application of the transient or change in condition to the point at which VOUT is within 1% of final value.
- Step load test is performed at 10 microseconds typical.
- Step line test is performed at 100 microseconds ± 20 microseconds.
- Tested on release from inhibit.
- Applicable to each output. No effect on dc performance.

MHV Single, Dual and Triple DC-DC Converters

28 VOLT INPUT – 15 WATT

TYPICAL PERFORMANCE PLOTS: 25°C CASE, 28 V_{IN}, 100% LOAD, UNLESS OTHERWISE SPECIFIED.
 THESE ARE EXAMPLES FOR REFERENCE ONLY AND ARE NOT GUARANTEED SPECIFICATIONS.

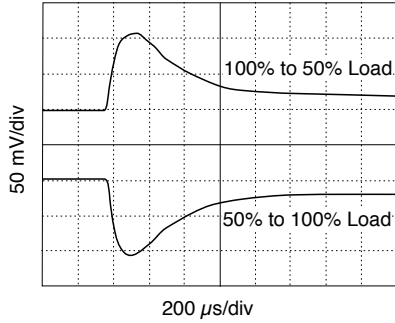

STEP LOAD RESPONSE MHV2805S

FIGURE 10

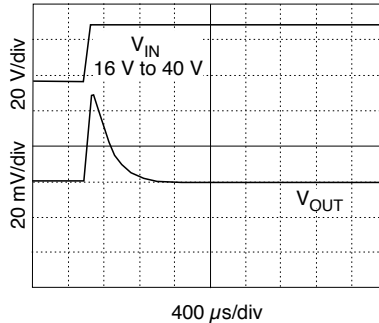

STEP LINE RESPONSE MHV2805S

FIGURE 11

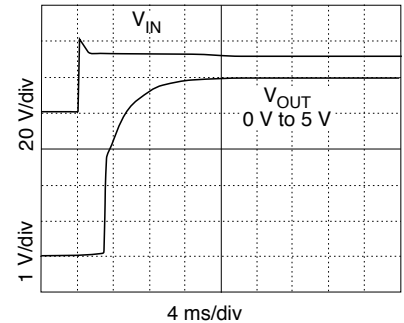

TURN ON RESPONSE MHV2805S

FIGURE 12

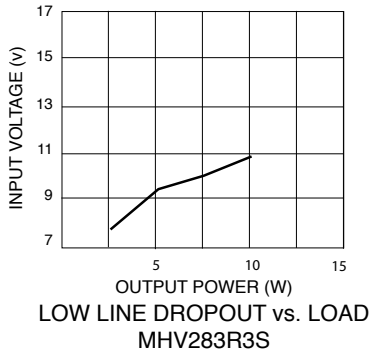

FIGURE 13

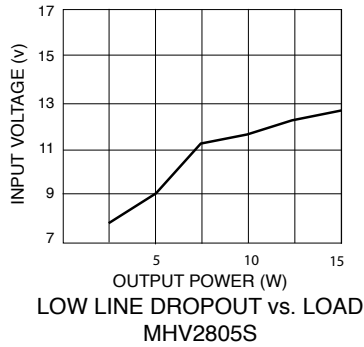

FIGURE 14

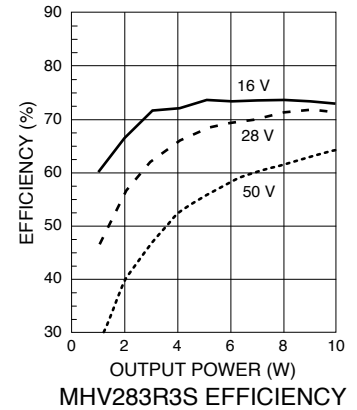

FIGURE 15

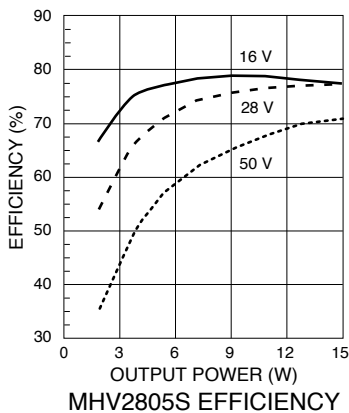

FIGURE 16

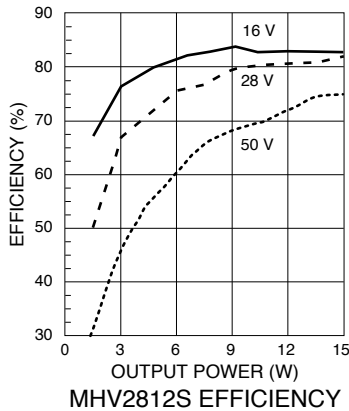

FIGURE 17

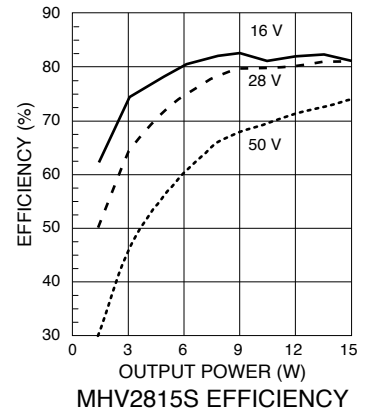
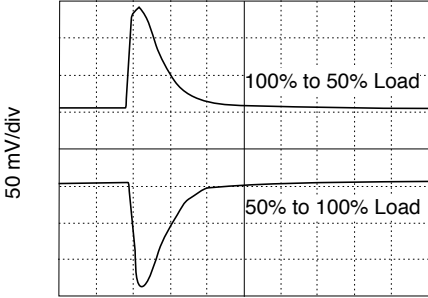

FIGURE 18

MHV Single, Dual and Triple DC-DC Converters

28 VOLT INPUT – 15 WATT

TYPICAL PERFORMANCE PLOTS: 25°C CASE, 28 VIN, 100% LOAD, UNLESS OTHERWISE SPECIFIED. THESE ARE EXAMPLES FOR REFERENCE ONLY AND ARE NOT GUARANTEED SPECIFICATIONS.



400 μ s/div
**+V_{OUT} STEP LOAD RESPONSE
MHV2815D**

FIGURE 19

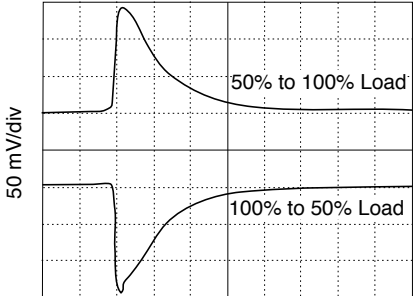

200 μ s/div
**-V_{OUT} STEP LOAD RESPONSE
MHV2815D**

FIGURE 20

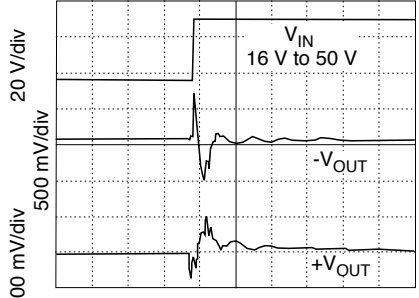

40 μ s/div
STEP LINE RESPONSE MHV2815D

FIGURE 21

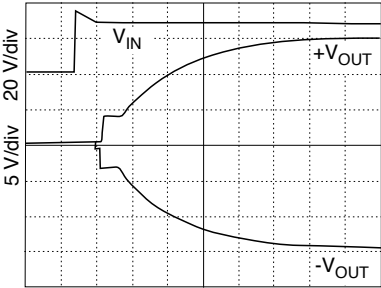

2 ms/div
TURN ON RESPONSE MHV2815D

FIGURE 22

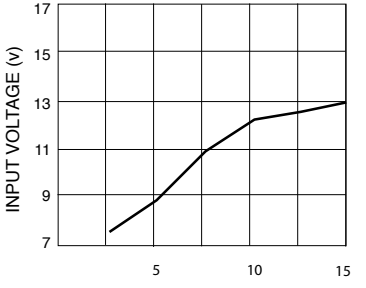

**LOW LINE DROPOUT vs. LOAD
MHV2815D**

FIGURE 23

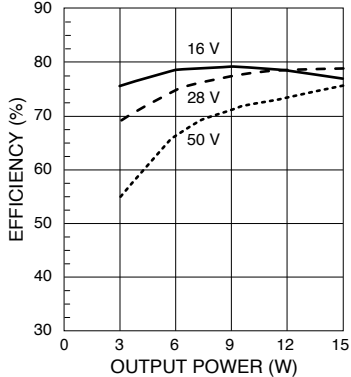

**MHV2805D EFFICIENCY
FIGURE 24**

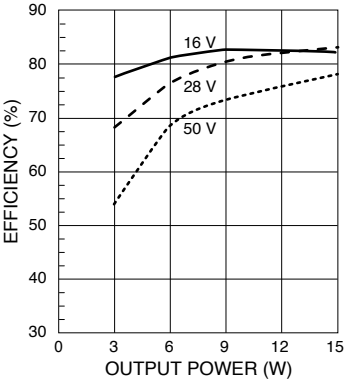

MHV2812D EFFICIENCY

FIGURE 25

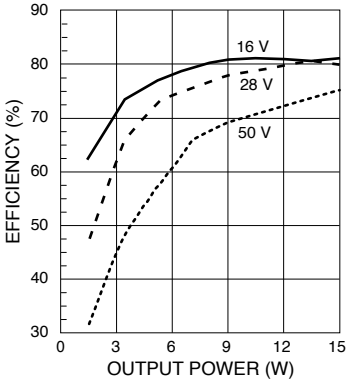

MHV2815D EFFICIENCY

FIGURE 26

MHV Single, Dual and Triple DC-DC Converters

28 VOLT INPUT – 15 WATT

TYPICAL PERFORMANCE PLOTS: 25°C CASE, 28 VIN, 100% LOAD, UNLESS OTHERWISE SPECIFIED.
THESE ARE EXAMPLES FOR REFERENCE ONLY AND ARE NOT GUARANTEED SPECIFICATIONS.

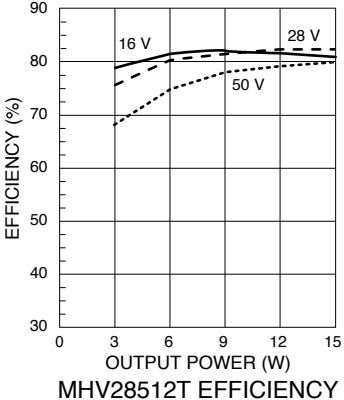

FIGURE 27

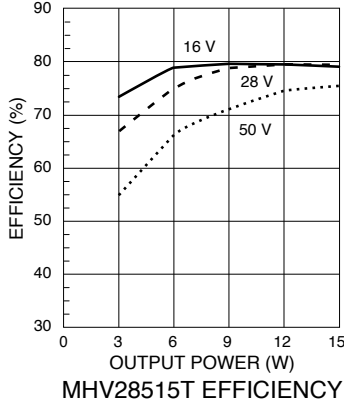
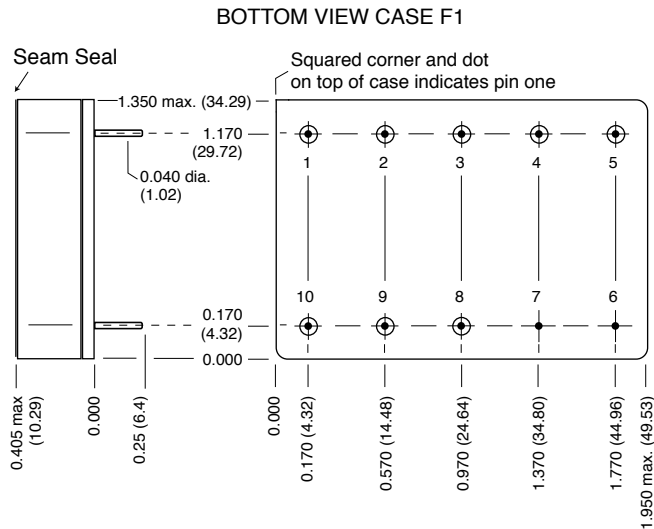

FIGURE 28

MHV Single, Dual and Triple DC-DC Converters

28 VOLT INPUT – 15 WATT



Weight: 60 grams maximum

Case dimensions in inches (mm)

Tolerance ± 0.005 (0.13) for three decimal places
 ± 0.01 (0.3) for two decimal places
 unless otherwise specified

CAUTION

Heat from reflow or wave soldering may damage the device.
 Solder pins individually with heat application not exceeding 300°C for 10 seconds per pin.

Materials

Header Cold Rolled Steel/Nickel/Gold
 Cover Kovar/Nickel
 Pins #52 alloy/Gold ceramic seal
 Gold plating of 50 - 150 microinches included in pin diameter
 Seal hole 0.120 \pm 0.002 (3.05 \pm 0.05)

Case F1 MHV T, Rev G, 2014.01.13
 Please refer to the numerical dimensions for accuracy.

FIGURE 29: CASE F1 - MHV TRIPLE

MHV Single, Dual and Triple DC-DC Converters

28 VOLT INPUT – 15 WATT

BOTTOM VIEW CASE H2

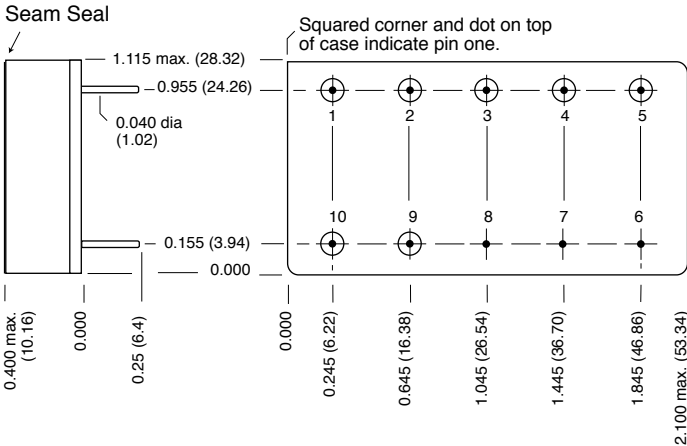

Weight: 60 grams maximum

Case dimensions in inches (mm)
Tolerance ± 0.005 (0.13) for three decimal places
 ± 0.01 (0.3) for two decimal places
unless otherwise specified

CAUTION
Heat from reflow or wave soldering may damage the device.
Solder pins individually with heat application not exceeding 300°C for 10 seconds per pin.

Materials
Header Cold Rolled Steel/Nickel/Gold
Cover Kovar/Nickel
Pins #52 alloy/Gold ceramic seal
Gold plating of 50 - 150 microinches included in pin diameter
Seal hole 0.120 ± 0.002 (3.05 ± 0.05)

Case H2 MHV S&D, Rev H 2014.01.13
Please refer to the numerical dimensions for accuracy.

FIGURE 30: CASE H2 - MHV SINGLE AND DUAL

MHV Single, Dual and Triple DC-DC Converters

28 VOLT INPUT – 15 WATT

BOTTOM VIEW CASE J1

Flanged cases: Designator "F" required in Case Option position of model number.

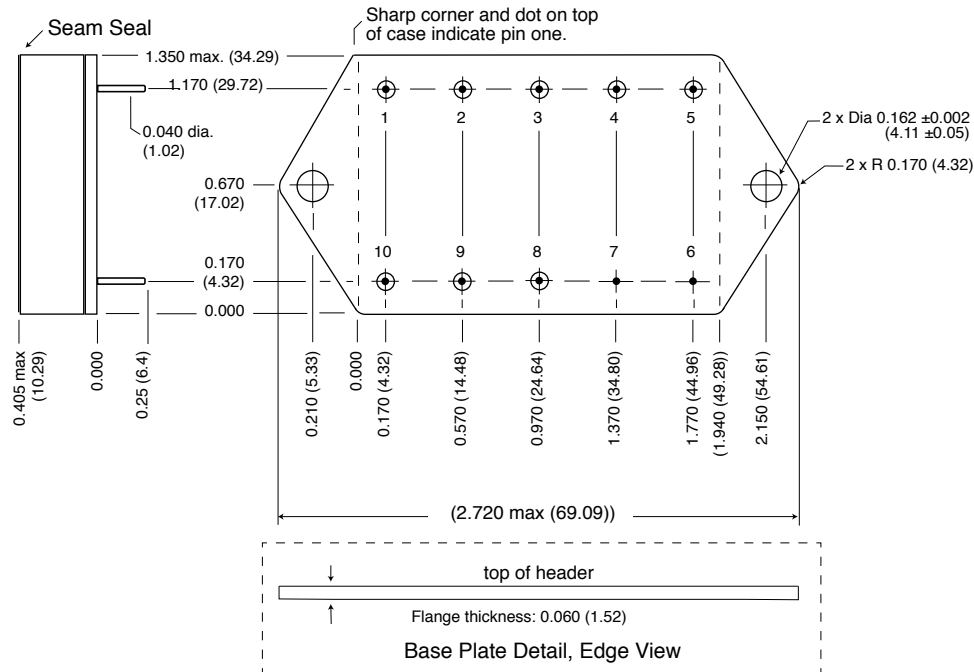

Weight: 60 grams maximum

Case dimensions in inches (mm)

Tolerance ±0.005 (0.13) for three decimal places
 ±0.01 (0.3) for two decimal places
 unless otherwise specified

CAUTION

Heat from reflow or wave soldering may damage the device.
 Solder pins individually with heat application not exceeding 300°C for 10 seconds per pin.

Materials

Header Cold Rolled Steel/Nickel/Gold
 Cover Kovar/Nickel
 Pins #52 alloy/Gold ceramic seal
 Gold plating of 50 - 150 microinches included in pin diameter
 Seal hole 0.120 ±0.002 (3.05 ± 0.05)

Please refer to the numerical dimensions for accuracy.

FIGURE 31: CASE J1 - MHV TRIPLE

MHV Single, Dual and Triple DC-DC Converters

28 VOLT INPUT – 15 WATT

BOTTOM VIEW CASE K3

Flanged cases: Designator "F" required in Case Option position of model number.

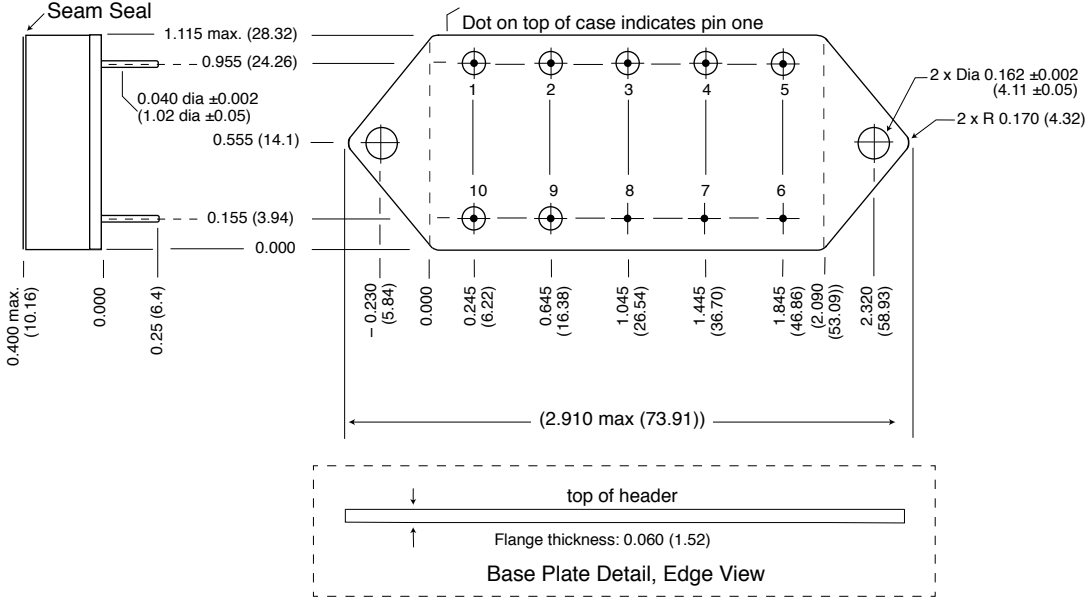

Weight: 60 grams maximum

Case dimensions in inches (mm)
Tolerance ±0.005 (0.13) for three decimal places
±0.01 (0.3) for two decimal places
unless otherwise specified

CAUTION
Heat from reflow or wave soldering may damage the device. Solder pins individually with heat application not exceeding 300°C for 10 seconds per pin.

Materials
Header Cold Rolled Steel/Nickel/Gold
Cover Kovar/Nickel
Pins #52 alloy/Gold, compression glass seal
Gold plating of 50 - 150 microinches included in pin diameter
Seal hole 0.092 ±0.002 (2.34 ± 0.05)

Please refer to the numerical dimensions for accuracy.

FIGURE 32: CASE K3 - MHV SINGLE AND DUAL

MHV Single, Dual and Triple DC-DC Converters

28 VOLT INPUT – 15 WATT

ELEMENT EVALUATION ¹ HIGH RELIABILITY /883 (CLASS H)

COMPONENT-LEVEL TEST PERFORMED	QML	
	CLASS H /883	
	M/S ²	P ³
Element Electrical	■	■
Visual	■	■
Internal Visual	■	
Final Electrical	■	■
Wire Bond Evaluation	■	■

Notes

1. Element evaluation does not apply to standard and /ES product.
2. M/S = Active components (microcircuit and semiconductor die).
3. P = Passive components, Class H element evaluation. Not applicable to standard and /ES element evaluation.

TABLE 13: ELEMENT EVALUATION

MHV Single, Dual and Triple DC-DC Converters

28 VOLT INPUT – 15 WATT

ENVIRONMENTAL SCREENING HIGH RELIABILITY STANDARD, /ES AND /883 (CLASS H)

TEST PERFORMED	NON-QML ¹		QML ²
	STANDARD	/ES	CLASS H /883
Pre-cap Inspection, Method 2017, 2032	■	■	■
Temperature Cycle (10 times)			
Method 1010, Cond. C, -65°C to +150°C, ambient			■
Method 1010, Cond. B, -55°C to +125°C, ambient		■	
Constant Acceleration			
Method 2001, 3000 g			■
Method 2001, 500 g		■	
PIND, Test Method 2020, Cond. A			■ ³
Burn-in Method 1015, +125°C case, typical ⁴			
96 hours		■	
160 hours			■
Final Electrical Test, MIL-PRF-38534, Group A,			
Subgroups 1 through 6, -55°C, +25°C, +125°C case			■
Subgroups 1 and 4, +25°C case	■	■	
Hermeticity Test			
Gross Leak, Cond. C ₁ , fluorocarbon		■	■
Fine Leak, Cond. A ₂ , helium		■	■
Gross Leak, Dip	■		
Final visual inspection, Method 2009	■	■	■

Test methods are referenced to MIL-STD-883 as determined by MIL-PRF-38534.

Notes

- Standard and ES are non-QML products and may not meet all of the requirements of MIL-PRF-38534.
- All processes are QML qualified and performed by certified operators.
- Not required by DLA but performed to assure product quality.
- Burn-in temperature designed to bring the case temperature to +125°C minimum.
Burn-in is a powered test.

TABLE 14: ENVIRONMENTAL SCREENING