

MFK Single and Dual DC-DC Converters

16 TO 50 VOLTS INPUT – 25 WATT

FEATURES

- 16 to 50 volt input
- Up to 87% efficiency, 42 W/in³
- Available to Class H, MIL-PRF-38534
- Undervoltage lockout
- -55°C to +125°C operation
- Fully isolated, magnetic feedback
- Fixed frequency, 500 kHz typical
- 80 volt transient protection per MIL-STD-704A
- Inhibit and sync function
- Indefinite short circuit protection



MODELS	
OUTPUT VOLTAGE (V)	
SINGLE	DUAL
1.8	±5
2.5	±7
3.3	±12
5	±15
5.2	
5.7	
12	
15	
28	

DESCRIPTION

The Interpoint® MFK Series™ of DC-DC converters offers up to 25 watts of power in a low profile package. The MFK converters are manufactured in our fully certified and qualified MIL-PRF-38534 Class H production facility and packaged in hermetically sealed steel cases. They are ideal for use in programs requiring high reliability, small size, and high efficiency. The high frequency series offers a wide input voltage range of 16 to 50 volts and up to 25 watts of output power. The converters provide 80 volt transient protection per MIL-STD-704A. The package is a hermetically sealed, welded metal case. Flanged and non-flanged models are available.

CONVERTER DESIGN

The MFK converters are switching regulators that use a quasi-square wave, single-ended forward converter design with a constant switching frequency of 500 kHz, typical. Isolation between input and output circuits is provided with transformers in the power path and in the feedback control loop.

At 0.360 inch high and a total footprint of 1.7 in², this low profile package offers a total power density of up to 42 watts per cubic inch.

The dual models can be used as a single output voltage by connecting the load between positive and negative outputs, leaving the common unconnected, resulting in double the output voltage. (for example, MFK2815D can be used as a 30 volt output.) When using a dual to double the output voltage (span voltage) the maximum load capacitance across the span voltage is half that specified for each output.

AUDIO REJECTION AND FILTERING

The MFK converters current mode control system provides excellent dynamic response and audio rejection. Audio rejection is typically 50 dB. Output voltage response for a 50% to 100% step load transient is as low as 4% with a 400 μ s recovery time.

The MFK Series converters are provided with internal filtering capacitors that help reduce the need for external components in normal operation. Use our FMCE-0528 EMI filter to meet the requirements of MIL-STD-461C CE03 and CS01 and MIL-STD-461D, E and F CE102 and CS101. Any of our Interpoint FMCE filters can be used to the rated current of the filter.

INHIBIT AND SYNCHRONIZATION

MFK converters provide an inhibit terminal that can be used to disable internal switching, resulting in no output and very low quiescent input current. The converter is inhibited when the inhibit pin is pulled below 0.8 volts. The converter is enabled when the pin, which is internally connected to a pull-up current source, is left unconnected or is connected to an open-collector gate. The open circuit voltage associated with the inhibit pin is 8.5 to 12 V. In the inhibit mode, a maximum of 4 mA must be sunk from the inhibit pin.

A synchronization feature is included with the MFK Series that allows the user to match the switching frequency of the converter to the frequency of a system clock. Synchronization allows the user to adjust the nominal 500 kHz operating frequency to any frequency within the range of 450 kHz to 550 kHz. This is initiated by applying an active high input of the desired frequency to the sync pin. See Table 5 on page 5 for more information.

SHORT CIRCUIT PROTECTION

MFK Series converters provide indefinite short circuit protection by folding back the output voltage at approximately 125% of the full load output current.

UNDERVOLTAGE LOCKOUT

Undervoltage lockout with hysteresis prevents the converters from operating below approximately 15 volts input voltage to keep system current levels smooth, especially during initialization or re-start operations.

MFK Single and Dual DC-DC Converters

16 TO 50 VOLTS INPUT – 25 WATT

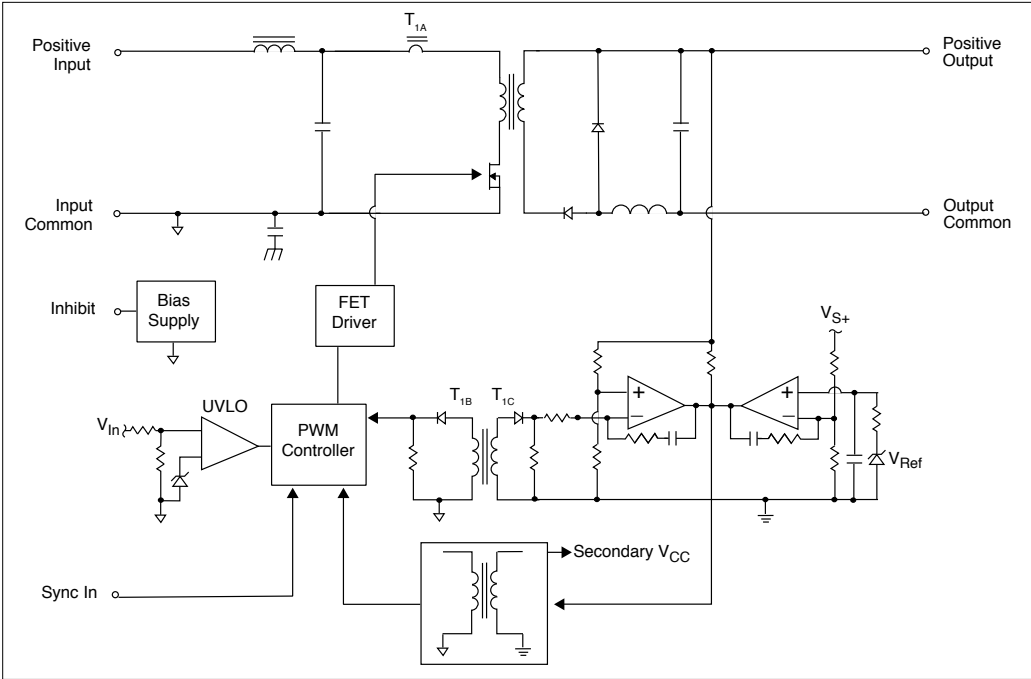

FIGURE 1: MFK SINGLE BLOCK DIAGRAM

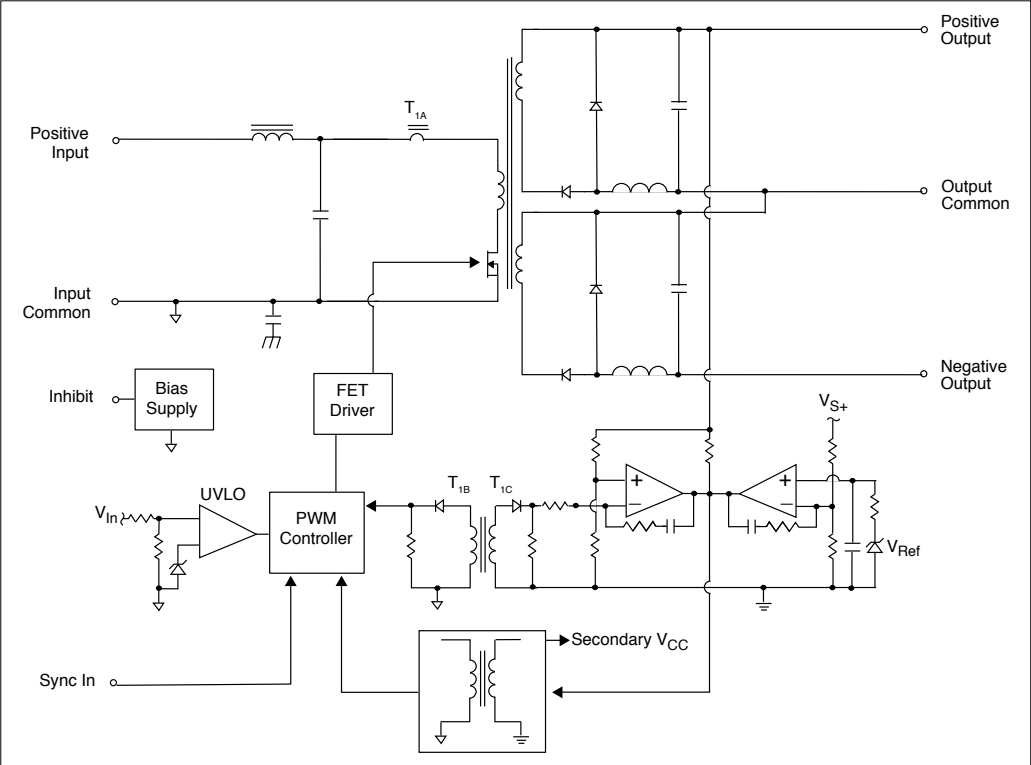

FIGURE 2: MFK DUAL BLOCK DIAGRAM

MFK Single and Dual DC-DC Converters

16 TO 50 VOLTS INPUT – 25 WATT

PIN OUT			
Pin	Single Output	MFK2828S	Dual Output
1	Inhibit	Inhibit	Inhibit
2	Output Common	Positive Output	Positive Output
3	Positive Output	No Connection	Output Common
4	Sync In	Output Common	Negative Output
5	Case Ground	Sync In	Sync In
6	Input Common	Case Ground	Case Ground
7	Positive Input	Input Common	Input Common
8	—	Positive Input	Positive Input

TABLE 1: PIN OUT

PINS NOT IN USE	
Inhibit	Leave unconnected
Sync	Leave unconnected

TABLE 2: PINS NOT IN USE

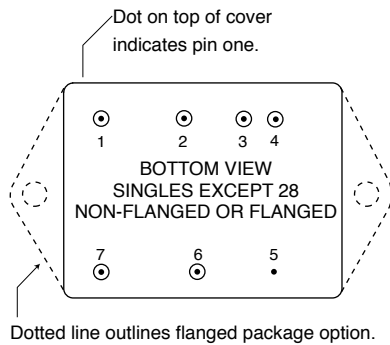

See Figure 32 on page 18 and Figure 34 on page 20 for dimensions.

FIGURE 3: MFK SINGLE PIN OUT (EXCEPT 28S)

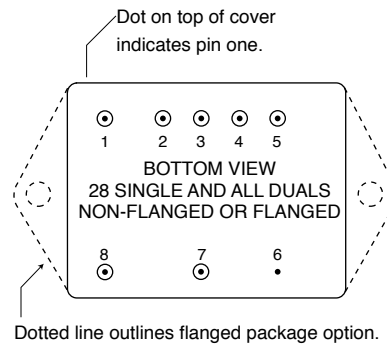

See Figure 33 on page 19 and Figure 35 on page 21 for dimensions.

FIGURE 4: MFK DUAL PIN OUT (INCLUDES 28S)

MFK Single and Dual DC-DC Converters

16 TO 50 VOLTS INPUT – 25 WATT

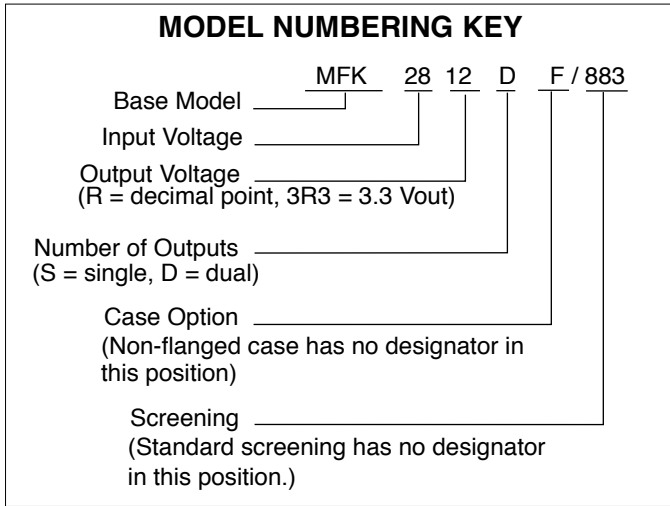

FIGURE 5: MODEL NUMBERING KEY

SMD NUMBERS	
STANDARD MICROCIRCUIT DRAWING (SMD)	MFK SIMILAR PART
5962-1421010HXC	MFK281R8S/883
5962-1421011HXC	MFK282R5S/883
5962-1421012HXC	MFK283R3S/883
5962-1421013HXC	MFK2805S/883
5962-1421018HXC	MFK285R2S/883
5962-1421014HXC	MFK285R7S/883
5962-1421015HXC	MFK2812S/883
5962-1421016HXC	MFK2815S/883
5962-1421017HTC	MFK2828S/883
5962-1421105HXC	MFK2805D/883
5962-1421106HXC	MFK2807D/883
5962-1421107HXC	MFK2812D/883
5962-1421108HXC	MFK2815D/883

The SMD number shown is for Class H screening, non-flanged. To indicate the flanged case option change the "X" to "Z" in the SMD number ("T" to "U" for 28 single). For exact specifications for an SMD product, refer to the SMD drawing. SMDs can be downloaded from: <https://landandmaritimeapps.dla.mil/programs/smcr>

TABLE 3: SMD CROSS REFERENCE

MODEL NUMBER OPTIONS					
TO DETERMINE THE MODEL NUMBER ENTER ONE OPTION FROM EACH CATEGORY IN THE FORM BELOW.					
CATEGORY	Base Model and Input Voltage	Output Voltage ¹	Number of Outputs ²	Case Options ³	Screening ⁴
OPTIONS	MFK28	1R8, 2R5, 3R3, 05 5R2, 5R7, 12, 15, 28	S	(non-flanged, leave blank)	(standard, leave blank)
		05, 07, 12, 15	D	F (flanged)	ES 883
FILL IN FOR MODEL # ⁵	MFK28	_____	_____	_____	/ _____

Notes

- Output Voltage: An R indicates a decimal point. 1R8 is 1.8 volts out. The values of 1.8, 2.5, 3.3 and 5.7 volts are only available in single output models.
- Number of Outputs: S is a single output and D is a dual output.
- Case Options: For the standard case, Figure 32 on page 18 or Figure 33 on page 19, leave the case option blank. For the flanged case option, Figure 34 on page 20 or Figure 35 on page 21, insert the letter F in the Case Option position.
- Screening: For standard screening leave the screening option blank. For other screening options, insert the desired screening level. For more information see Table 11 on page 22 and Table 12 on page 23.
- If ordering by model number add a "-Q" to request solder dipped leads (MFK2805S/883-Q). Available only for Class H.

TABLE 4: MODEL NUMBER OPTIONS

MFK Single and Dual DC-DC Converters

16 TO 50 VOLTS INPUT – 25 WATT

TABLE 5: OPERATING CONDITIONS, ALL MODELS, 25°C CASE, 28 VIN, 100% LOAD, UNLESS OTHERWISE SPECIFIED.

MFK SERIES	PARAMETER	CONDITIONS	ALL MODELS			UNITS
			MIN	TYP	MAX	
	LEAD SOLDERING TEMPERATURE ¹	10 SECONDS MAX.	–	–	300	°C
	STORAGE TEMPERATURE ¹		-65	–	+150	°C
	CASE OPERATING TEMPERATURE	FULL POWER	-55	–	+125	°C
		ABSOLUTE ¹	-55	–	+135	
	DERATING OUTPUT POWER/CURRENT ¹	LINEARLY	From 100% at 125°C to 0% at 135°C			
	ESD RATING ^{1, 2} MIL-PRF-38534, 3.9.5.8.2	MIL-STD-883, METHOD 3015 CLASS 2	2000 - 3999 ²			V
	ISOLATION: INPUT TO OUTPUT OR ANY PIN TO CASE EXCEPT CASE PIN	500 VDC AT 25°C	100	–	–	Megohms
	UNDERVOLTAGE LOCKOUT		–	15	–	V
	CURRENT LIMIT ³	% OF FULL LOAD	–	125	–	%
	AUDIO REJECTION ¹		–	50	–	dB
	SWITCHING FREQUENCY	-55°C TO +125°C	430	–	570	kHz
	SYNCHRONIZATION	INPUT FREQUENCY	450	–	550	kHz
		DUTY CYCLE ¹	40	–	60	%
		ACTIVE LOW	–	–	0.8	V
		ACTIVE HIGH ¹	4.5	–	5.0	
		REFERENCED TO	INPUT COMMON			
		IF NOT USED	LEAVE UNCONNECTED			
	INHIBIT ACTIVE LOW (OUTPUT DISABLED) Do not apply a voltage to the inhibit pin ⁵	INHIBIT PIN PULLED LOW ⁴	–	–	0.8	V
		INHIBIT PIN SOURCE CURRENT ¹	–	–	4	mA
		REFERENCED TO	INPUT COMMON			
	INHIBIT ACTIVE HIGH (OUTPUT ENABLED) Do not apply a voltage to the inhibit pin ⁵	INHIBIT PIN CONDITION	OPEN COLLECTOR OR UNCONNECTED			
		OPEN PIN VOLTAGE ¹	8.5	–	12	V

**For mean time between failures (MTBF) contact Applications Engineering
powerapps@craneae.com +1 425.882.3100 option 7**

Notes

1. Guaranteed by characterization test and/or analysis. Not a production test.
2. Passes 2000 volts.
3. Current limit is defined as the point at which the output voltage drops by 1%. Dual outputs: The over-current limit will trigger when the sum of the currents from both outputs reaches 125% (typical value) of the maximum rated "total" current of both outputs.

4. Tested with inhibit pin connected to input common.
5. An external inhibit interface should be used to pull the inhibit low or leave it floating. The inhibit pin can be left unconnected if not used.

MFK Single and Dual DC-DC Converters

16 TO 50 VOLTS INPUT – 25 WATT

TABLE 6: ELECTRICAL CHARACTERISTICS -55°C TO +125°C CASE, 28 VIN, 100% LOAD, UNLESS OTHERWISE SPECIFIED.

SINGLE OUTPUT MODELS		MFK281R8S			MFK282R5S			MFK283R3S			UNITS
PARAMETER	CONDITIONS	MIN	TYP	MAX	MIN	TYP	MAX	MIN	TYP	MAX	
OUTPUT VOLTAGE		1.74	1.80	1.86	2.42	2.50	2.58	3.20	3.30	3.40	V
OUTPUT CURRENT ²	V _{IN} = 16 TO 50	—	—	5.56	—	—	5.0	—	—	4.55	A
OUTPUT POWER ²	V _{IN} = 16 TO 50	—	—	10	—	—	12.5	—	—	15	W
OUTPUT RIPPLE	T _C = 25°C	—	30	60	—	30	60	—	25	60	mV p-p
10 kHz - 20 MHz	T _C = -55°C TO +125°C	—	35	80	—	35	80	—	30	80	
LINE REGULATION	V _{IN} = 16 TO 50	—	5	20	—	5	20	—	5	20	mV
LOAD REGULATION	NO LOAD TO FULL	—	10	25	—	5	25	—	5	25	mV
INPUT VOLTAGE	CONTINUOUS	16	28	50	16	28	50	16	28	50	V
NO LOAD TO FULL	TRANSIENT ^{1, 3}	—	—	80	—	—	80	—	—	80	V
INPUT CURRENT	NO LOAD	—	25	50	—	25	50	—	25	50	mA
	INHIBITED	—	2.5	4	—	2.5	4	—	2.5	4	
INPUT RIPPLE CURRENT	10 kHz - 20 MHz	—	30	75	—	30	80	—	30	80	mA p-p
EFFICIENCY	TC = 25°C	69	72	—	73	76	—	76	79	—	%
	TC = -55°C TO +125°C	67	—	—	71	—	—	74	—	—	
LOAD FAULT ^{4, 5}	POWER DISSIPATION	—	—	8.5	—	—	8.5	—	—	8.5	W
SHORT CIRCUIT	RECOVERY ¹	—	—	20	—	—	20	—	—	20	ms
STEP LOAD RESPONSE ^{6, 7}	TRANSIENT	—	±125	±200	—	±125	±200	—	±125	±200	mV pk
50% - 100% - 50%	RECOVERY	—	200	400	—	100	300	—	200	300	
STEP LINE RESPONSE ^{1, 6, 8}	TRANSIENT	—	—	±350	—	—	±350	—	—	±350	mV pk
16 - 50 - 16 V	RECOVERY	—	0.5	1	—	0.5	1	—	0.5	1	
START-UP ^{6, 9}	DELAY	—	—	25	—	—	25	—	—	25	ms
FULL LOAD	OVERSHOOT ¹	—	—	50	—	—	50	—	—	50	mV pk
CAPACITIVE LOAD ¹	NO EFFECT ON DC	—	—	2000	—	—	2000	—	—	2000	μF
T _C = 25°C	PERFORMANCE	—	—	2000	—	—	2000	—	—	2000	

Notes

1. Guaranteed by characterization test and/or analysis. Not a production test.
2. At loads <20% of full load, higher input ripple current is possible.
3. The converters provide 80 volt transient protection per MIL-STD-704A.
4. Short circuit measured with 1% 10 milliohm resistive load.
5. Indefinite short circuit protection not guaranteed above 125°C case.

6. Recovery and start-up times are measured from application of the transient or change in condition to the point at which V_{OUT} is within 1% of final value.
7. Step load test is performed at 10 microseconds typical.
8. Step line test is performed at 100 microseconds ± 20 microseconds.
9. Tested on release from inhibit.

MFK Single and Dual DC-DC Converters

16 TO 50 VOLTS INPUT – 25 WATT

TABLE 7: ELECTRICAL CHARACTERISTICS -55°C TO +125°C CASE, 28 VIN, 100% LOAD, UNLESS OTHERWISE SPECIFIED.

SINGLE OUTPUT MODELS		MFK2805S			MFK285R2S			MFK285R7S			UNITS
PARAMETER	CONDITIONS	MIN	TYP	MAX	MIN	TYP	MAX	MIN	TYP	MAX	
OUTPUT VOLTAGE		4.85	5.00	5.15	5.05	5.2	5.35	5.52	5.70	5.87	V
OUTPUT CURRENT ²	V _{IN} = 16 TO 50	—	—	4.0	—	—	4	—	—	4.0	A
OUTPUT POWER ²	V _{IN} = 16 TO 50	—	—	20	—	—	20.8	—	—	22.8	W
OUTPUT RIPPLE	T _C = 25°C	—	40	80	—	40	80	—	40	80	mV p-p
10 kHz - 20 MHz	T _C = -55°C TO +125°C	—	—	100	—	—	100	—	—	100	
LINE REGULATION	V _{IN} = 16 TO 50	—	5	20	—	5	20	—	5	20	mV
LOAD REGULATION	NO LOAD TO FULL	—	5	25	—	5	25	—	5	25	mV
INPUT VOLTAGE	CONTINUOUS	16	28	50	16	28	50	16	28	50	V
NO LOAD TO FULL	TRANSIENT ^{1, 3}	—	—	80	—	—	80	—	—	80	V
INPUT CURRENT	NO LOAD	—	25	50	—	25	50	—	25	50	mA
	INHIBITED	—	2.4	4	—	2.4	4	—	2.4	4	
INPUT RIPPLE CURRENT	10 kHz - 20 MHz	—	23	85	—	23	85	—	25	85	mA p-p
EFFICIENCY	T _C = 25°C	79	82	—	79	82	—	79	82	—	%
	T _C = -55°C TO +125°C	77	—	—	77	—	—	77	—	—	
LOAD FAULT ^{4, 5}	POWER DISSIPATION	—	6	8.5	—	6	8.5	—	6	8.5	W
SHORT CIRCUIT	RECOVERY ¹	—	—	20	—	—	20	—	—	20	ms
STEP LOAD RESPONSE ^{6, 7}	TRANSIENT	—	—	±400	—	—	±400	—	—	±400	mV pk
50% - 100% - 50%	RECOVERY	—	—	300	—	—	300	—	—	300	
STEP LINE RESPONSE ^{1, 6, 8}	TRANSIENT	—	—	±500	—	—	±500	—	—	±570	mV pk
16 - 50 - 16 V	RECOVERY	—	0.5	1	—	0.5	1	—	0.5	1	
START-UP ^{6, 9}	DELAY	—	—	25	—	—	25	—	—	25	ms
FULL LOAD	OVERSHOOT ¹	—	0	50	—	0	50	—	0	50	mV pk
CAPACITIVE LOAD ¹	NO EFFECT ON DC	—	—	2000	—	—	2000	—	—	2000	μF
T _C = 25°C	PERFORMANCE	—	—	2000	—	—	2000	—	—	2000	

Notes

1. Guaranteed by characterization test and/or analysis. Not a production test.
2. At loads <20% of full load, higher input ripple current is possible.
3. The converters provide 80 volt transient protection per MIL-STD-704A.
4. Short circuit measured with 1% 10 milliohm resistive load.
5. Indefinite short circuit protection not guaranteed above 125°C case.

6. Recovery and start-up times are measured from application of the transient or change in condition to the point at which V_{OUT} is within 1% of final value.
7. Step load test is performed at 10 microseconds typical.
8. Step line test is performed at 100 microseconds ± 20 microseconds.
9. Tested on release from inhibit.

MFK Single and Dual DC-DC Converters

16 TO 50 VOLTS INPUT – 25 WATT

TABLE 8: ELECTRICAL CHARACTERISTICS -55°C TO +125°C CASE, 28 VIN, 100% LOAD, UNLESS OTHERWISE SPECIFIED.

SINGLE OUTPUT MODELS		MFK2812S			MFK2815S			MFK2828S			UNITS
PARAMETER	CONDITIONS	MIN	TYP	MAX	MIN	TYP	MAX	MIN	TYP	MAX	
OUTPUT VOLTAGE		11.76	12.00	12.24	14.70	15.00	15.30	27.16	28.00	28.84	V
OUTPUT CURRENT ²	V _{IN} = 16 TO 50	—	—	2.08	—	—	1.67	—	—	0.89	A
OUTPUT POWER ²	V _{IN} = 16 TO 50	—	—	25	—	—	25	—	—	25	W
OUTPUT RIPPLE 10 kHz - 20 MHz	T _C = 25°C	—	35	80	—	40	80	—	80	150	mV p-p
	T _C = -55°C TO +125°C	—	—	100	—	50	100	—	100	200	
LINE REGULATION	V _{IN} = 16 TO 50	—	5	20	—	5	20	—	150	280	mV
LOAD REGULATION	NO LOAD TO FULL	—	5	20	—	5	20	—	150	280	mV
INPUT VOLTAGE	CONTINUOUS	16	28	50	16	28	50	16	28	50	V
NO LOAD TO FULL	TRANSIENT ^{1, 3}	—	—	80	—	—	80	—	—	80	V
INPUT CURRENT	NO LOAD	—	20	50	—	20	50	—	30	55	mA
	INHIBITED	—	2.5	4	—	2.5	4	—	2.5	4	
INPUT RIPPLE CURRENT	10 kHz - 20 MHz	—	45	90	—	50	110	—	50	100	mA p-p
EFFICIENCY	T _C = 25°C	83	86	—	84	87	—	81	84	—	%
	T _C = -55°C TO +125°C	81	—	—	82	—	—	80	—	—	
LOAD FAULT ^{4, 5}	POWER DISSIPATION	—	6	8.5	—	6	8	—	6	8.5	W
SHORT CIRCUIT	RECOVERY ¹	—	—	20	—	—	20	—	—	20	ms
STEP LOAD RESPONSE ^{6, 7} 50% - 100% - 50%	TRANSIENT	—	±350	±500	—	±400	±600	—	±900	±1200	mV pk
	RECOVERY	—	300	500	—	300	500	—	500	600	μs
STEP LINE RESPONSE ^{1, 6, 8} 16 - 50 - 16 V	TRANSIENT	—	—	±1300	—	—	±1500	—	—	±2800	mV pk
	RECOVERY	—	0.5	1	—	0.5	1	—	0.5	1	ms
START-UP ^{6, 9}	DELAY	—	—	25	—	—	25	—	—	25	ms
FULL LOAD	OVERSHOOT ¹	—	0	120	—	0	150	—	0	280	mV pk
CAPACITIVE LOAD ¹ T _C = 25°C	NO EFFECT ON DC	—	—	2000	—	—	2000	—	—	1000	μF
	PERFORMANCE	—	—	2000	—	—	2000	—	—	1000	

Notes

1. Guaranteed by characterization test and/or analysis. Not a production test.
2. At loads <20% of full load, higher input ripple current is possible.
3. The converters provide 80 volt transient protection per MIL-STD-704A.
4. Short circuit measured with 1% 10 milliohm resistive load.
5. Indefinite short circuit protection not guaranteed above 125°C case.

6. Recovery and start-up times are measured from application of the transient or change in condition to the point at which V_{OUT} is within 1% of final value.
7. Step load test is performed at 10 microseconds typical.
8. Step line test is performed at 100 microseconds ± 20 microseconds.
9. Tested on release from inhibit.

MFK Single and Dual DC-DC Converters

16 TO 50 VOLTS INPUT – 25 WATT

TABLE 9: ELECTRICAL CHARACTERISTICS -55°C TO +125°C CASE, 28 VIN, 100% LOAD, UNLESS OTHERWISE SPECIFIED.

DUAL OUTPUT MODELS		MFK2805D			MFK2807D			UNITS
PARAMETER	CONDITIONS	MIN	TYP	MAX	MIN	TYP	MAX	
OUTPUT VOLTAGE	+ V _{OUT}	4.85	5.00	5.15	6.86	7.00	7.14	V
	- V _{OUT}	4.82	5.00	5.18	6.83	7.00	7.17	
OUTPUT CURRENT ^{2, 3} V _{IN} = 16 TO 50 V	EITHER OUTPUT	—	±2.0	2.80	—	±1.5	2.10	A
	TOTAL OUTPUT	—	—	4.0	—	—	3.0	
OUTPUT POWER ^{2, 3} V _{IN} = 16 TO 50 V	EITHER OUTPUT	—	±10	14	—	±10.5	14.7	W
	TOTAL OUTPUT	—	—	20	—	—	21	
OUTPUT RIPPLE ±V _{OUT} , 10 kHz - 20 MHz	T _C = 25°C	—	—	80	—	—	70	mV p-p
	T _C = -55°C TO +125°C	—	—	90	—	—	80	
LINE REGULATION V _{IN} = 16 TO 50 V	+ V _{OUT}	—	5	20	—	5	20	mV
	- V _{OUT}	—	20	100	—	20	100	
LOAD REGULATION NL TO FULL, BALANCED	+ V _{OUT}	—	5	20	—	5	20	mV
	- V _{OUT}	—	35	250	—	50	250	
CROSS REGULATION ⁴	T _C = 25°C	—	—	360	—	—	400	mV
INPUT VOLTAGE	CONTINUOUS	16	28	50	16	28	50	V
	TRANSIENT ^{1, 5}	—	—	80	—	—	80	V
INPUT CURRENT	NO LOAD	—	30	50	—	30	50	mA
	INHIBITED	—	2.5	4	—	2.5	4	
INPUT RIPPLE CURRENT	10 kHz - 20 MHz	—	35	70	—	35	70	mA p-p
EFFICIENCY	T _C = 25°C	78	81	—	81	83	—	%
	T _C = -55°C TO +125°C	76	—	—	79	—	—	
LOAD FAULT ^{6, 7}	POWER DISSIPATION	—	6	8.5	—	6	8	W
SHORT CIRCUIT	RECOVERY ¹	—	15	20	—	15	20	ms
STEP LOAD RESPONSE ^{8, 9, 10} 50%-100%-50%, BALANCED LOADS	TRANSIENT ±V _{OUT}	—	±100	±450	—	±125	±500	mV pk
	RECOVERY	—	200	500	—	200	500	μs
STEP LINE RESPONSE ^{1, 8, 11} ±V _{OUT} , V _{IN} = 16 - 50 - 16 V	TRANSIENT	—	—	±500	—	—	±700	mV pk
	RECOVERY	—	0.5	1	—	0.5	1	ms
START-UP ^{8, 12}	DELAY	—	—	20	—	—	20	ms
	OVERSHOOT ¹	—	0	50	—	0	70	mV pk
CAPACITIVE LOAD ^{1, 13} T _C = 25°C	NO EFFECT ON DC	—	—	1000	—	—	1000	μF
	PERFORMANCE	—	—	1000	—	—	1000	

Notes

1. Guaranteed by characterization test and/or analysis. Not a production test.
2. Up to 70% of the total output power is available from either output providing the opposite output is simultaneously carrying 30% of the total output power.
3. At loads <20% of full load, higher input ripple current is possible (sum of both outputs).
4. Effect on -V_{out} for the following conditions:
+P_o = 30% to 70%; - P_o = 70% to 30%
5. The converters provide 80 volt transient protection per MIL-STD-704A.
6. Short circuit measured with 1% 10 milliohm resistive load.
7. Indefinite short circuit protection not guaranteed above 125°C case.

8. Recovery and start-up times are measured from application of the transient or change in condition to the point at which V_{OUT} is within 1% of final value.
9. Response of either output with the opposite output held at half of the total output power.
10. Step load test is performed at 10 microseconds typical.
11. Step line test is performed at 100 microseconds ± 20 microseconds.
12. Tested on release from inhibit.
13. Each output.

MFK Single and Dual DC-DC Converters

16 TO 50 VOLTS INPUT – 25 WATT

TABLE 10: ELECTRICAL CHARACTERISTICS -55°C TO +125°C CASE, 28 VIN, 100% LOAD, UNLESS OTHERWISE SPECIFIED.

DUAL OUTPUT MODELS		MFK2812D			MFK2815D			UNITS
PARAMETER	CONDITIONS	MIN	TYP	MAX	MIN	TYP	MAX	
OUTPUT VOLTAGE	+ V _{OUT}	11.76	12.00	12.24	14.70	15.00	15.30	V
	- V _{OUT}	11.70	12.00	12.30	14.63	15.00	15.38	
OUTPUT CURRENT ^{2, 3} V _{IN} = 16 TO 50 V	EITHER OUTPUT	—	±1.04	1.45	—	±0.833	1.16	A
	TOTAL OUTPUT	—	—	2.08	—	—	1.66	
OUTPUT POWER ^{2, 3} V _{IN} = 16 TO 50 V	EITHER OUTPUT	—	±12.5	17.5	—	±12.5	17.5	W
	TOTAL OUTPUT	—	—	25	—	—	25	
OUTPUT RIPPLE ±V _{OUT} , 10 kHz - 20 MHz	T _C = 25°C	—	—	90	—	—	90	mV p-p
	T _C = -55°C TO +125°C	—	—	90	—	—	90	
LINE REGULATION V _{IN} = 16 TO 50 V	+ V _{OUT}	—	5	20	—	5	20	mV
	- V _{OUT}	—	20	150	—	20	150	
LOAD REGULATION NL TO FULL, BALANCED	+ V _{OUT}	—	5	20	—	5	20	mV
	- V _{OUT}	—	60	250	—	100	250	
CROSS REGULATION ⁴	T _C = 25°C	—	—	700	—	—	800	mV
INPUT VOLTAGE	CONTINUOUS	16	28	50	16	28	50	V
	TRANSIENT ^{1, 5}	—	—	80	—	—	80	V
INPUT CURRENT	NO LOAD	—	30	50	—	30	50	mA
	INHIBITED	—	2.5	4	—	2.5	4	
INPUT RIPPLE CURRENT	10 kHz - 20 MHz	—	50	100	—	40	100	mA p-p
EFFICIENCY	T _C = 25°C	82	85	—	83	86	—	%
	T _C = -55°C TO +125°C	80	—	—	81	—	—	
LOAD FAULT ^{6, 7}	POWER DISSIPATION	—	5	8	—	5	8	W
SHORT CIRCUIT	RECOVERY ¹	—	15	20	—	15	20	ms
STEP LOAD RESPONSE ^{8, 9, 10} 50%-100%-50%, BALANCED LOADS	TRANSIENT ±V _{OUT}	—	±350	±600	—	±400	±650	mV pk
	RECOVERY	—	250	550	—	250	550	μs
STEP LINE RESPONSE ^{1, 8, 11} ±V _{OUT} , V _{IN} = 16 - 50 - 16 V	TRANSIENT	—	—	±1300	—	—	±1500	mV pk
	RECOVERY	—	0.5	1	—	0.5	1	ms
START-UP ^{8, 12}	DELAY	—	—	20	—	—	20	ms
	OVERSHOOT ¹	—	0	120	—	0	150	mV pk
CAPACITIVE LOAD ^{1, 13} T _C = 25°C	NO EFFECT ON DC	—	—	1000	—	—	1000	μF
	PERFORMANCE	—	—	1000	—	—	1000	

Notes

- Guaranteed by characterization test and/or analysis. Not a production test.
- Up to 70% of the total output power is available from either output providing the opposite output is simultaneously carrying 30% of the total output power.
- At loads <20% of full load, higher input ripple current is possible (sum of both outputs).
- Effect on -V_{out} for the following conditions:
+P_o = 30% to 70%; - P_o = 70% to 30%
- The converters provide 80 volt transient protection per MIL-STD-704A.
- Short circuit measured with 1% 10 milliohm resistive load.
- Indefinite short circuit protection not guaranteed above 125°C case.

- Recovery and start-up times are measured from application of the transient or change in condition to the point at which V_{OUT} is within 1% of final value.
- Response of either output with the opposite output held at half of the total output power.
- Step load test is performed at 10 microseconds typical.
- Step line test is performed at 100 microseconds ± 20 microseconds.
- Tested on release from inhibit.
- Each output.

MFK Single and Dual DC-DC Converters

16 TO 50 VOLTS INPUT – 25 WATT

TYPICAL PERFORMANCE PLOTS: 25°C CASE, 28 VIN, 100% LOAD, UNLESS OTHERWISE SPECIFIED.
FOR REFERENCE ONLY, NOT GUARANTEED SPECIFICATIONS.

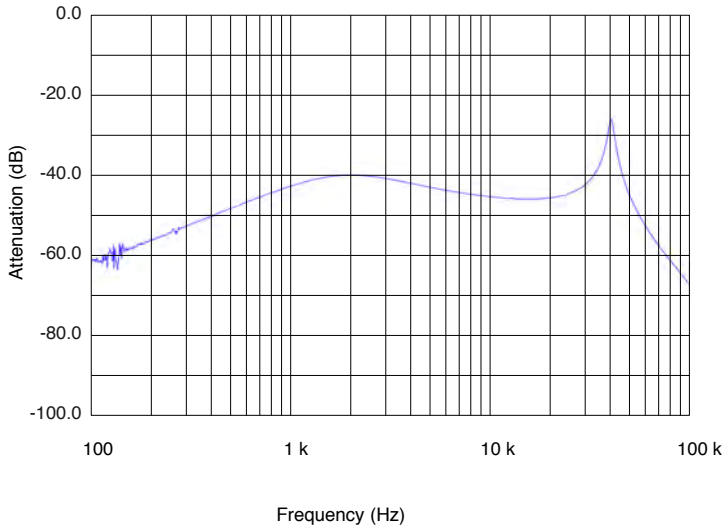

MFK SINGLE AUDIO REJECTION
FIGURE 6

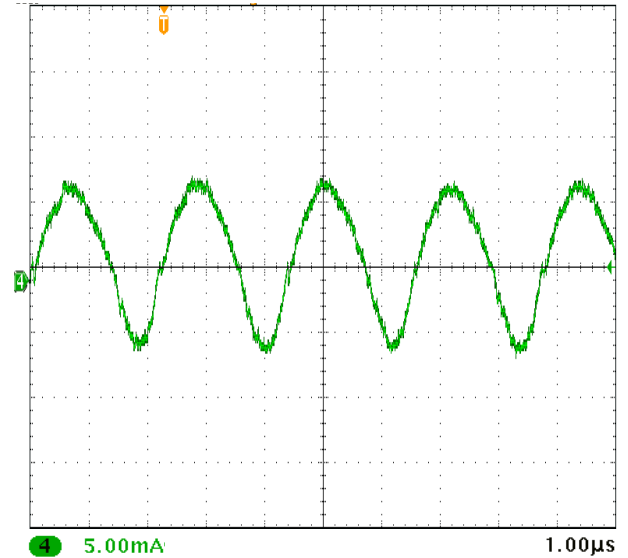

UNITS ARE PER DIVISION
MFK2805S INPUT RIPPLE
FIGURE 7

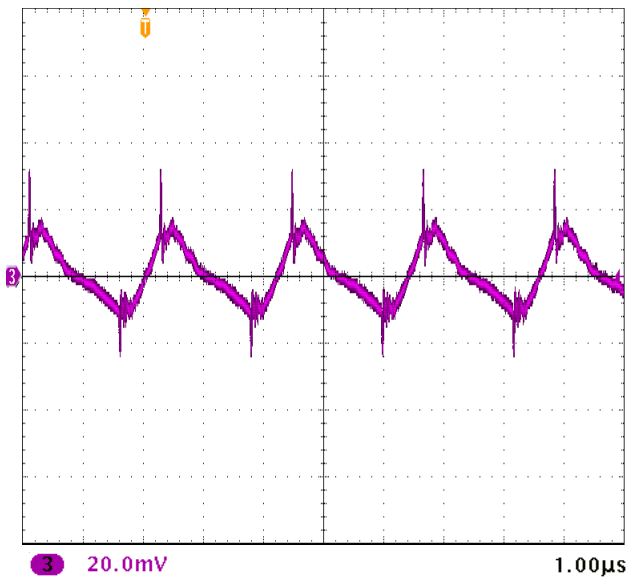

UNITS ARE PER DIVISION
MFK2805S OUTPUT RIPPLE

FIGURE 8

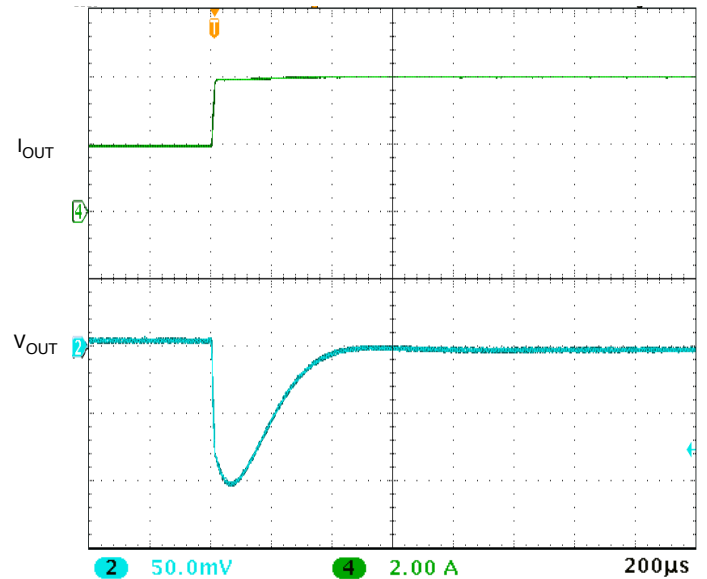

UNITS ARE PER DIVISION
MFK2805S STEP LOAD 50% - 100%

FIGURE 9

MFK Single and Dual DC-DC Converters

16 TO 50 VOLTS INPUT – 25 WATT

TYPICAL PERFORMANCE PLOTS: 25°C CASE, 28 VIN, 100% LOAD, UNLESS OTHERWISE SPECIFIED.
FOR REFERENCE ONLY, NOT GUARANTEED SPECIFICATIONS.

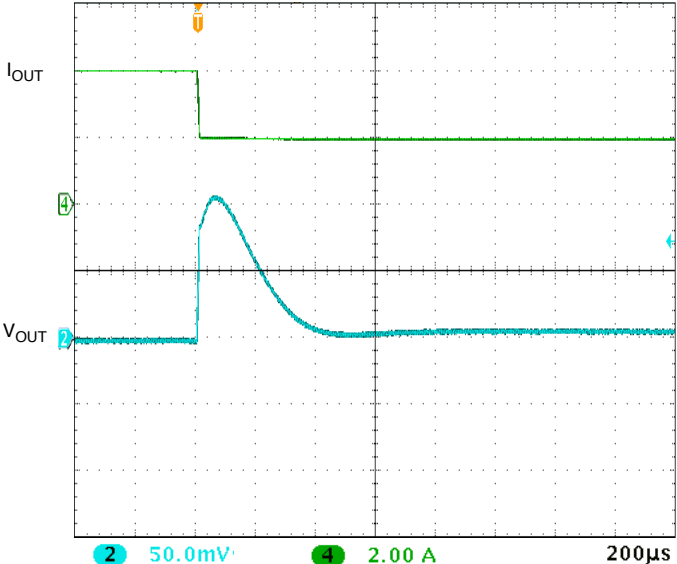

UNITS ARE PER DIVISION
MFK2805S STEP LOAD 100% - 50%

FIGURE 10

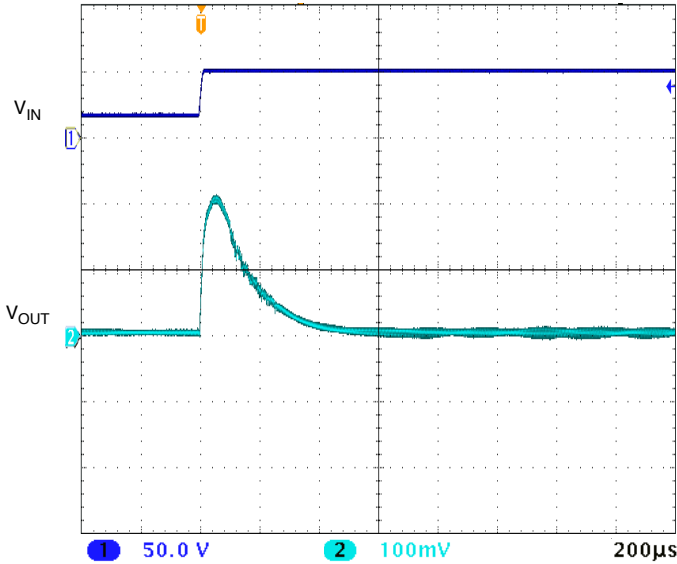

UNITS ARE PER DIVISION
MFK2805S STEP LINE 16 - 50 VOLTS 50% LOAD

FIGURE 11

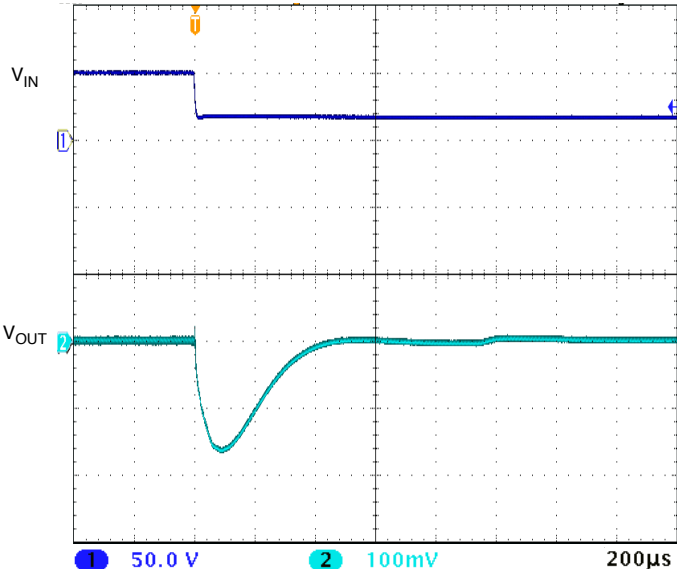

UNITS ARE PER DIVISION
MFK2805S STEP LINE 50 - 16 VOLTS 50% LOAD

FIGURE 12

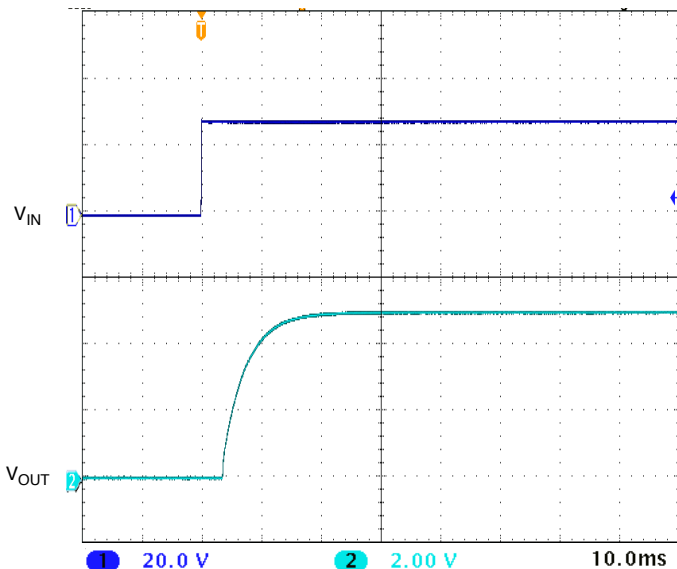

UNITS ARE PER DIVISION
MFK2805S START-UP FULL LOAD

FIGURE 13

MFK Single and Dual DC-DC Converters

16 TO 50 VOLTS INPUT – 25 WATT

TYPICAL PERFORMANCE PLOTS: 25°C CASE, 28 VIN, 100% LOAD, UNLESS OTHERWISE SPECIFIED.
FOR REFERENCE ONLY, NOT GUARANTEED SPECIFICATIONS.

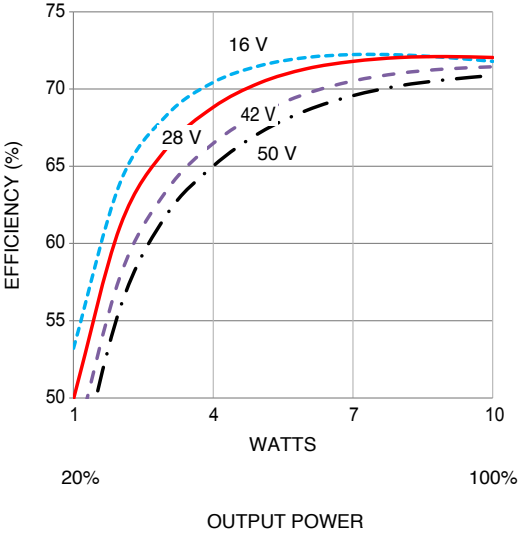

MFK281R8S EFFICIENCY

FIGURE 14

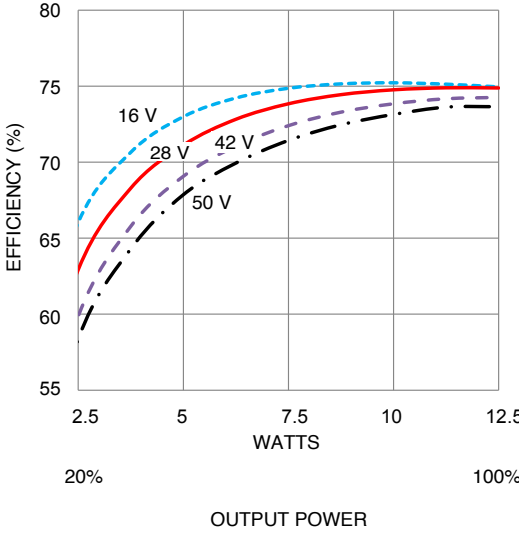

MFK282R5S EFFICIENCY

FIGURE 15

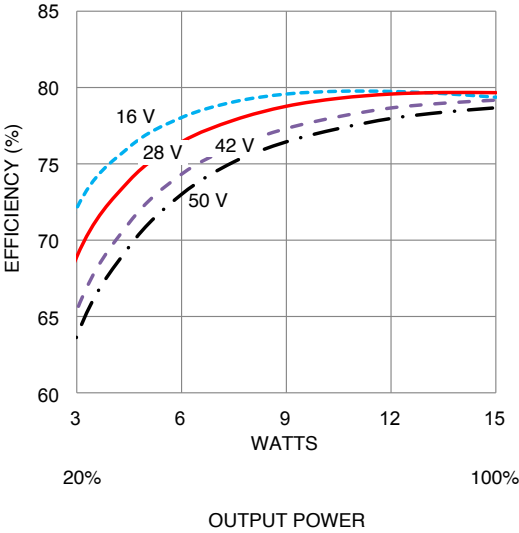

MFK283R3S EFFICIENCY

FIGURE 16

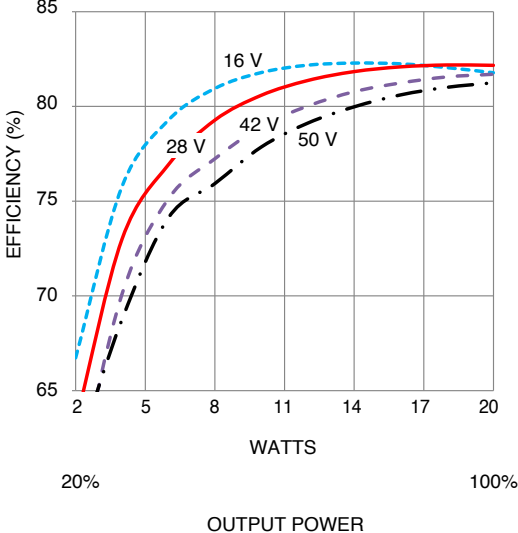

MFK2805S EFFICIENCY

FIGURE 17

MFK Single and Dual DC-DC Converters

16 TO 50 VOLTS INPUT – 25 WATT

TYPICAL PERFORMANCE PLOTS: 25°C CASE, 28 VIN, 100% LOAD, UNLESS OTHERWISE SPECIFIED.
FOR REFERENCE ONLY, NOT GUARANTEED SPECIFICATIONS.

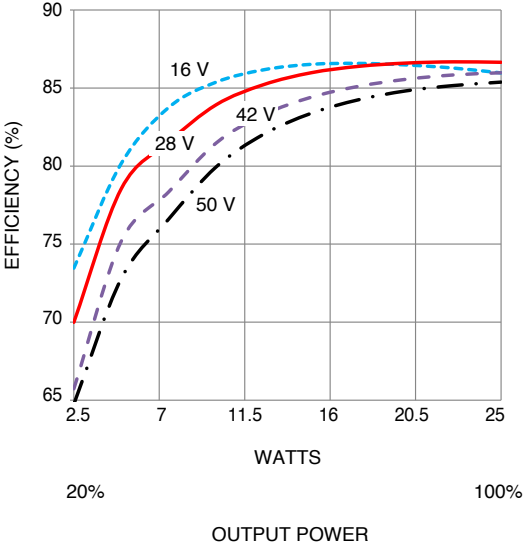

MFK2812S EFFICIENCY
FIGURE 18

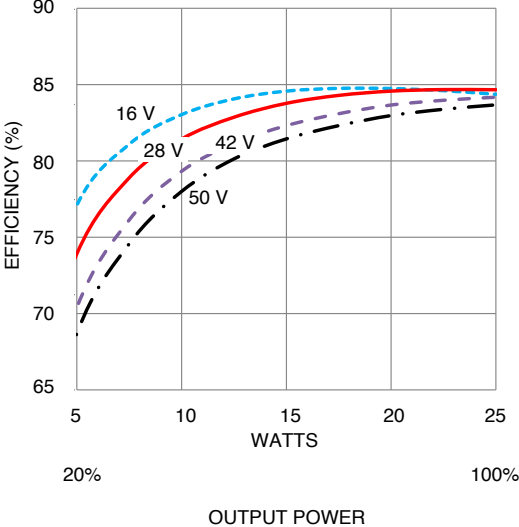

MFK2815S EFFICIENCY
FIGURE 19

MFK285R7S Efficiency will be added in the future.

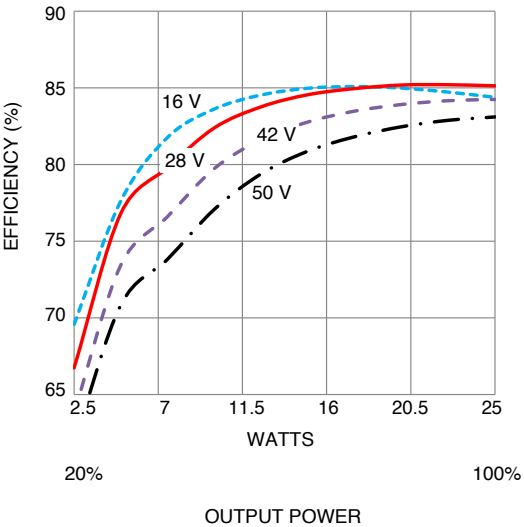

MFK2828S EFFICIENCY
FIGURE 20

MFK Single and Dual DC-DC Converters

16 TO 50 VOLTS INPUT – 25 WATT

TYPICAL PERFORMANCE PLOTS: 25°C CASE, 28 VIN, 100% LOAD, UNLESS OTHERWISE SPECIFIED.
FOR REFERENCE ONLY, NOT GUARANTEED SPECIFICATIONS.

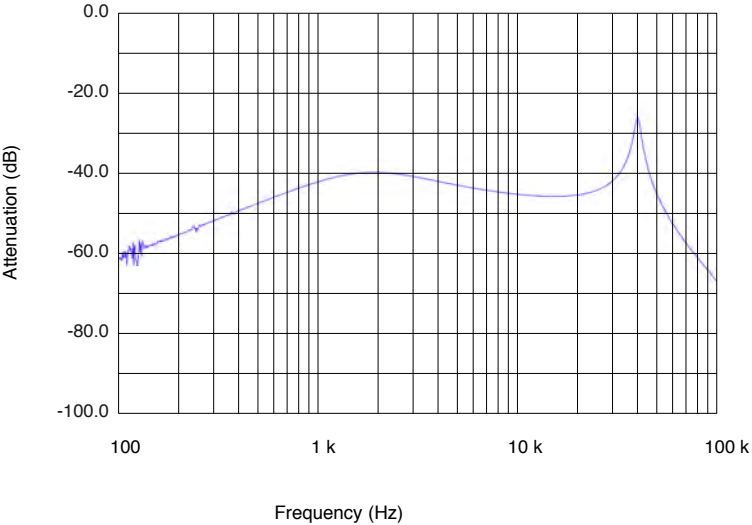

MFK DUAL AUDIO REJECTION

FIGURE 21

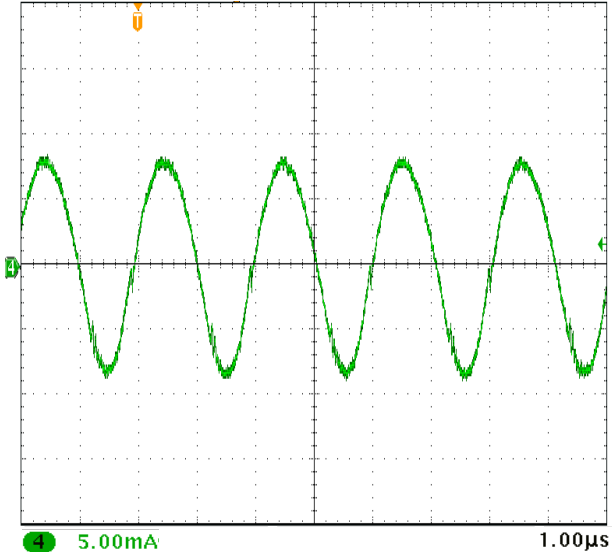

UNITS ARE PER DIVISION
MFK2815D INPUT RIPPLE

FIGURE 22

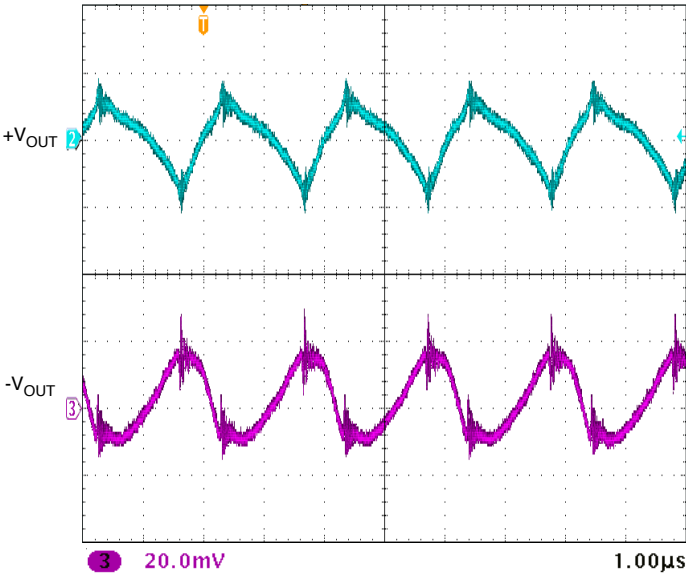

UNITS ARE PER DIVISION
MFK2815D OUTPUT RIPPLE

FIGURE 23

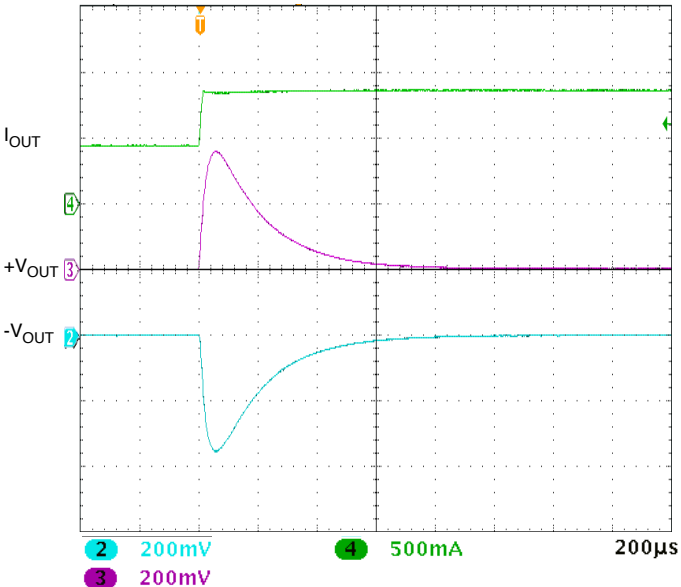

UNITS ARE PER DIVISION
MFK2815D STEP LOAD 50% - 100%

FIGURE 24

MFK Single and Dual DC-DC Converters

16 TO 50 VOLTS INPUT – 25 WATT

TYPICAL PERFORMANCE PLOTS: 25°C CASE, 28 VIN, 100% LOAD, UNLESS OTHERWISE SPECIFIED.
 FOR REFERENCE ONLY, NOT GUARANTEED SPECIFICATIONS.

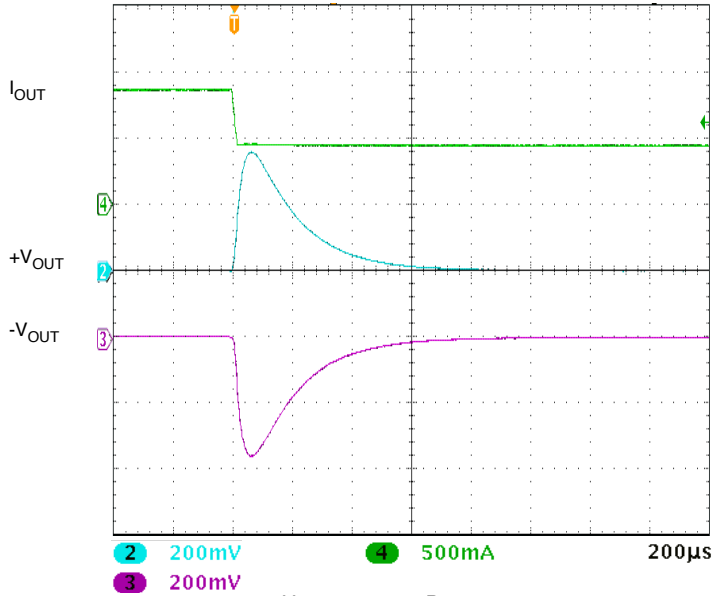

UNITS ARE PER DIVISION
 MFK2815D STEP LOAD 100% - 50%

FIGURE 25

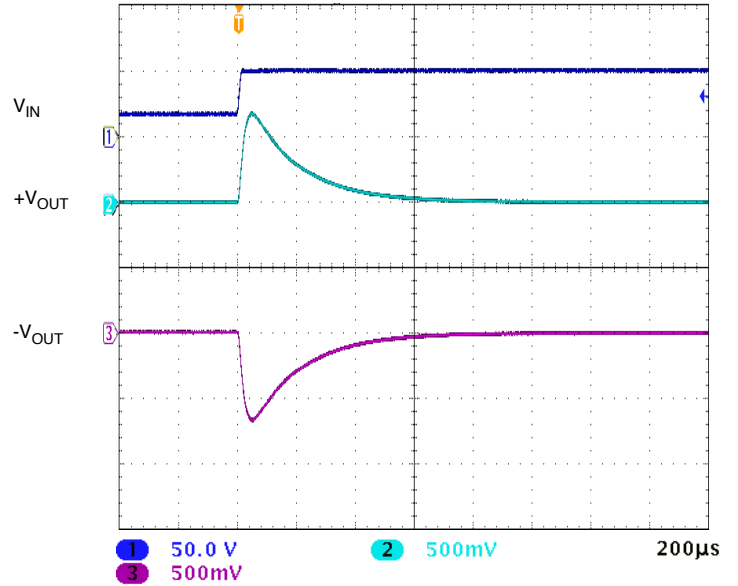

UNITS ARE PER DIVISION
 MFK2815D STEP LINE 16 - 50 VOLTS 50% LOAD

FIGURE 26

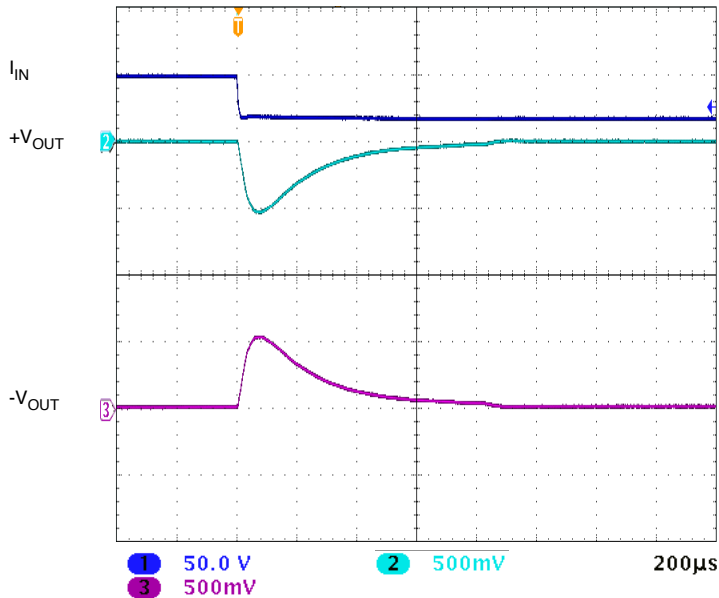

UNITS ARE PER DIVISION
 MFK2815D STEP LINE 50 - 16 VOLTS 50% LOAD

FIGURE 27

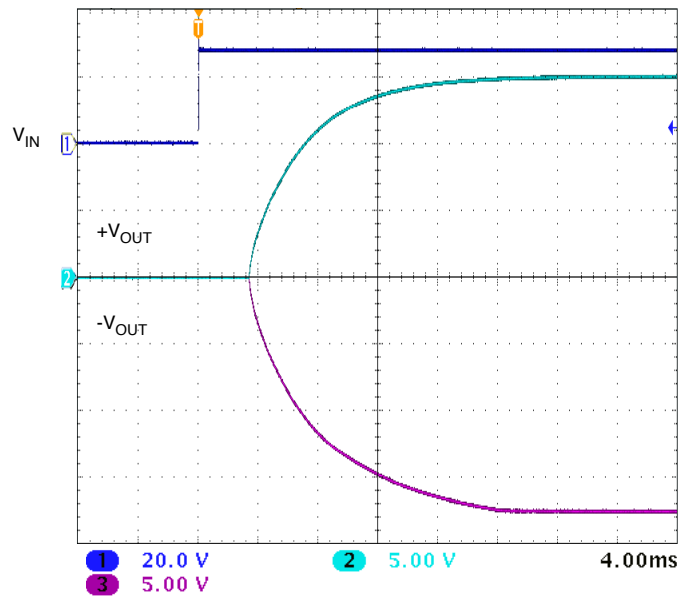

UNITS ARE PER DIVISION
 MFK2815D START-UP FULL LOAD

FIGURE 28

MFK Single and Dual DC-DC Converters

16 TO 50 VOLTS INPUT – 25 WATT

TYPICAL PERFORMANCE PLOTS: 25°C CASE, 28 VIN, 100% LOAD, UNLESS OTHERWISE SPECIFIED.
FOR REFERENCE ONLY, NOT GUARANTEED SPECIFICATIONS.

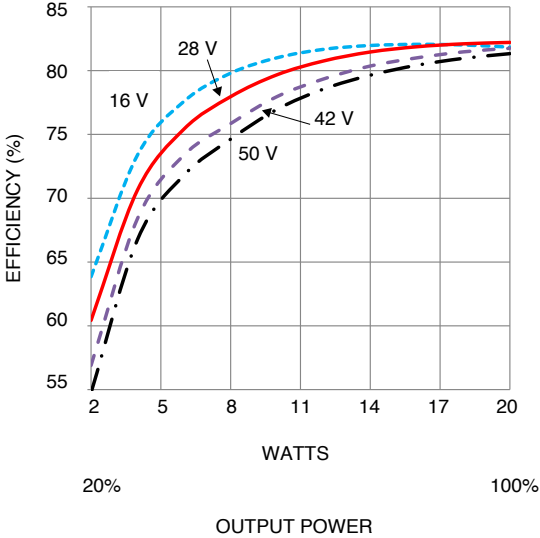

MFK2805D EFFICIENCY
FIGURE 29

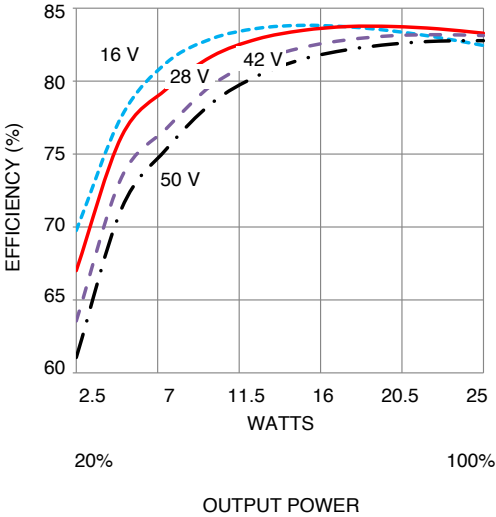

MFK2812D EFFICIENCY
FIGURE 30

MFK2807D Efficiency will be added in the future.

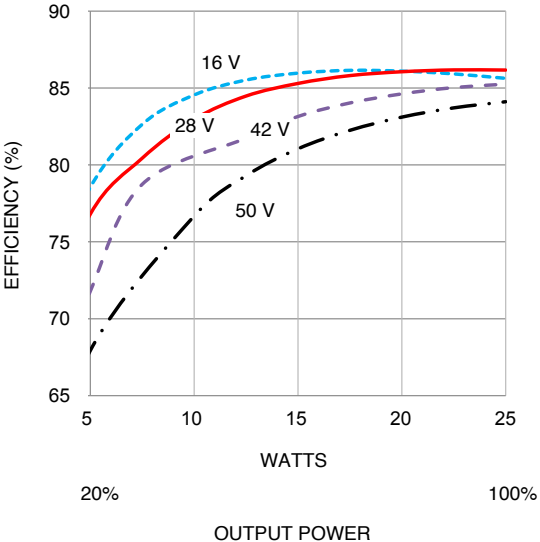

MFK2815D EFFICIENCY
FIGURE 31

MFK Single and Dual DC-DC Converters

16 TO 50 VOLTS INPUT – 25 WATT

BOTTOM VIEW MFK SINGLE

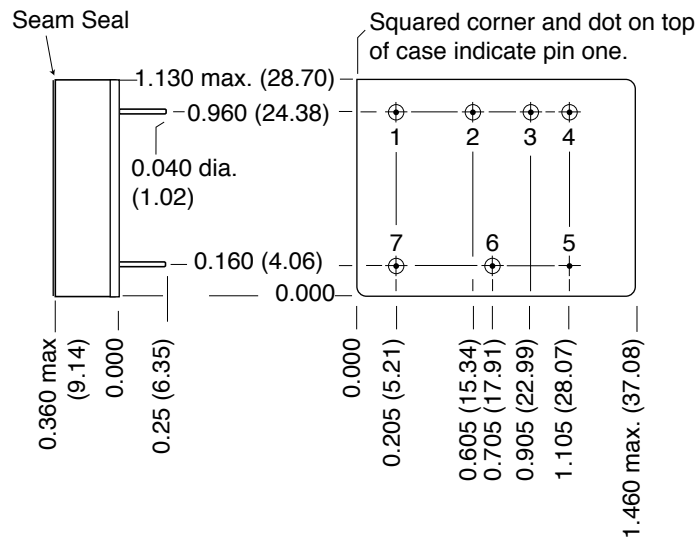

Weight: 38 grams maximum

Case dimensions in inches (mm)

Tolerance ± 0.005 (0.13) for three decimal places
 ± 0.01 (0.3) for two decimal places
 unless otherwise specified

CAUTION

Heat from reflow or wave soldering may damage the device. Solder pins individually with heat application not exceeding 300°C for 10 seconds per pin.

Materials

Header Cold Rolled Steel/Nickel/Gold

Cover Kovar/Nickel

Pins #52 alloy/Gold ceramic seal

Gold plating of 50 - 150 microinches included in pin diameter

Seal Hole: 0.123 \pm 0.002 (3.12 \pm 0.05)

Please refer to the numerical dimensions for accuracy.

FIGURE 32: MFK SINGLE OUTPUT
EXCEPT 28 VOLT SINGLE

MFK Single and Dual DC-DC Converters

16 TO 50 VOLTS INPUT – 25 WATT

BOTTOM VIEW MFK DUAL

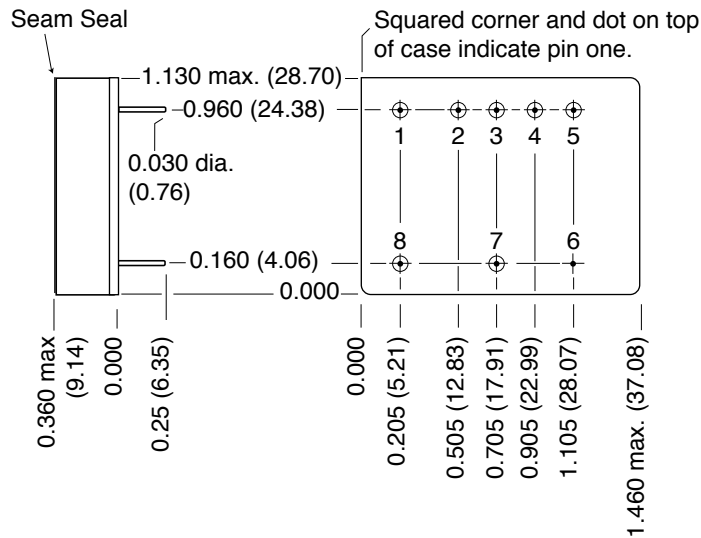

Weight: 38 grams maximum

Case dimensions in inches (mm)

Tolerance ± 0.005 (0.13) for three decimal places
 ± 0.01 (0.3) for two decimal places
 unless otherwise specified

CAUTION

Heat from reflow or wave soldering may damage the device. Solder pins individually with heat application not exceeding 300°C for 10 seconds per pin.

Materials

Header Cold Rolled Steel/Nickel/Gold

Cover Kovar/Nickel

Pins #52 alloy/Gold ceramic seal

Gold plating of 50 - 150 microinches included in pin diameter

Seal Hole: 0.091 ± 0.002 (2.31 ± 0.05)

Please refer to the numerical dimensions for accuracy.

FIGURE 33: MFK DUAL OUTPUT
 INCLUDES 28 VOLT SINGLE

MFK Single and Dual DC-DC Converters

16 TO 50 VOLTS INPUT – 25 WATT

BOTTOM VIEW MFK SINGLE FLANGED

Flanged cases: Designator "F" required in Case Option position of model number

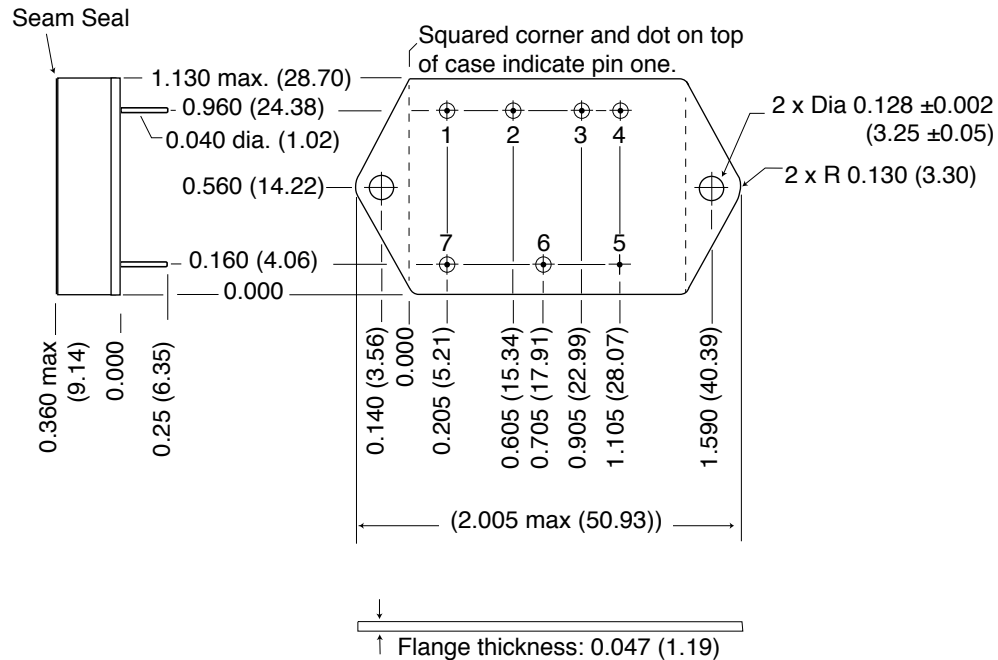

Weight: 38 grams maximum

Case dimensions in inches (mm)

Tolerance ±0.005 (0.13) for three decimal places
 ±0.01 (0.3) for two decimal places
 unless otherwise specified

CAUTION

Heat from reflow or wave soldering may damage the device. Solder pins individually with heat application not exceeding 300°C for 10 seconds per pin.

Materials

Header Cold Rolled Steel/Nickel/Gold
 Cover Kovar/Nickel
 Pins #52 alloy/Gold compression glass seal
 Gold plating of 50 - 150 microinches included in pin diameter
 Seal Hole: 0.123 ±0.002 (3.12 ±0.05)

Please refer to the numerical dimensions for accuracy.

FIGURE 34: MFK SINGLE OUTPUT FLANGED
 EXCEPT 28 VOLT SINGLE

MFK Single and Dual DC-DC Converters

16 TO 50 VOLTS INPUT – 25 WATT

BOTTOM VIEW CASE MFK DUAL FLANGED

Flanged cases: Designator "F" required in Case Option position of model number

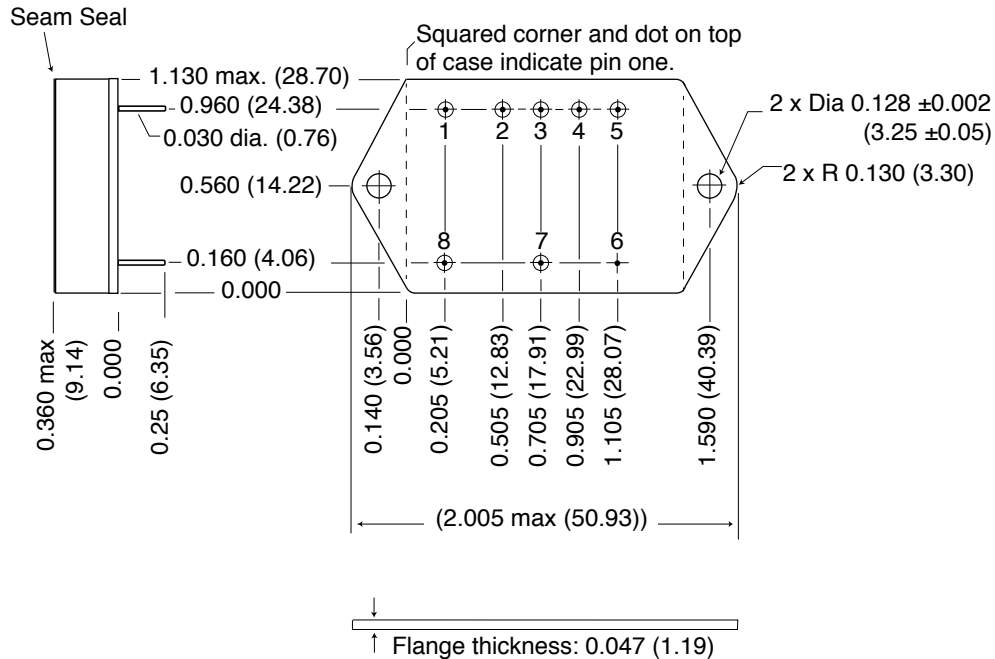

Weight: 38 grams maximum

Case dimensions in inches (mm)

Tolerance \pm 0.005 (0.13) for three decimal places
 \pm 0.01 (0.3) for two decimal places
 unless otherwise specified

CAUTION

Heat from reflow or wave soldering may damage the device. Solder pins individually with heat application not exceeding 300°C for 10 seconds per pin.

Materials

Header Cold Rolled Steel/Nickel/Gold
 Cover Kovar/Nickel
 Pins #52 alloy/Gold compression glass seal
 Gold plating of 50 - 150 microinches included in pin diameter
 Seal Hole: 0.091 \pm 0.002 (2.31 \pm 0.05)

Please refer to the numerical dimensions for accuracy.

FIGURE 35: MFK DUAL OUTPUT FLANGED
 INCLUDES 28 VOLT SINGLE

MFK Single and Dual DC-DC Converters

16 TO 50 VOLTS INPUT – 25 WATT

ELEMENT EVALUATION ¹ HIGH RELIABILITY /883 (CLASS H)

COMPONENT-LEVEL TEST PERFORMED	QML	
	CLASS H /883	
	M/S ²	P ³
Element Electrical	■	■
Visual	■	■
Internal Visual	■	
Final Electrical	■	■
Wire Bond Evaluation	■	■

- Notes
1. Element evaluation does not apply to standard and /ES product.
 2. M/S = Active components (microcircuit and semiconductor die).
 3. P = Passive components, Class H element evaluation. Not applicable to standard and /ES element evaluation.

TABLE 11: ELEMENT EVALUATION

MFK Single and Dual DC-DC Converters

16 TO 50 VOLTS INPUT – 25 WATT

ENVIRONMENTAL SCREENING HIGH RELIABILITY STANDARD, /ES AND /883 (CLASS H)

TEST PERFORMED	NON-QML ¹		QML ²
	STANDARD	/ES	CLASS H /883
Pre-cap Inspection, Method 2017, 2032	■	■	■
Temperature Cycle (10 times)			
Method 1010, Cond. C, -65°C to +150°C, ambient			■
Method 1010, Cond. B, -55°C to +125°C, ambient		■	
Constant Acceleration			
Method 2001, 3000 g			■
Method 2001, 500 g		■	
PIND, Test Method 2020, Cond. A			■ ³
Burn-in Method 1015, +125°C case, typical ⁴			
96 hours		■	
160 hours			■
Final Electrical Test, MIL-PRF-38534, Group A,			
Subgroups 1 through 6, -55°C, +25°C, +125°C case			■
Subgroups 1 and 4, +25°C case	■	■	
Hermeticity Test			
Gross Leak, Cond. C ₁ , fluorocarbon		■	■
Fine Leak, Cond. A ₂ , helium		■	■
Gross Leak, Dip	■		
Final visual inspection, Method 2009	■	■	■

Test methods are referenced to MIL-STD-883 as determined by MIL-PRF-38534.

Notes

- Standard and ES are non-QML products and may not meet all of the requirements of MIL-PRF-38534.
- All processes are QML qualified and performed by certified operators.
- Not required by DLA but performed to assure product quality.
- Burn-in temperature designed to bring the case temperature to +125°C minimum.
Burn-in is a powered test.

TABLE 12: ENVIRONMENTAL SCREENING